

34xx-0xxx, 3400-GATE  
Two Hole Mount

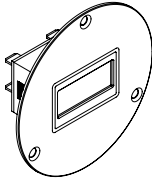

34xx-1xxx  
Three Hole Mount

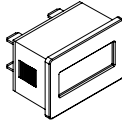

34xx-2xxx  
Rectangular Flush Mount

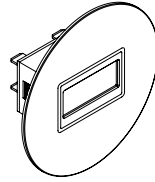

34xx-3xxx  
Round Flush Mount

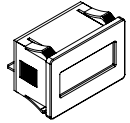

34xx-5xxx  
Rectangular Snap-in Mount

## Common Specification

<b>Display</b>	LCD 0.28" [7mm] high figures black on light background			
<b>Input Options</b>	<b>MODEL</b>	<b>RANGE</b>	<b>INPUT LOW</b>	<b>INPUT HIGH</b>
	<b>34x0</b>	10-300VDC 20-300VAC	<3VDC <3VAC	>10VDC >20VAC
	<b>34x1</b>	Dry Contact	n/a	n/a
	<b>34x3</b>	4.5-30VDC	<2VDC	>=4.5VDC
	<b>34xx-GATE</b>	4-30VDC	<1VDC	>=4VDC
<b>Power</b>	Self-powered battery life 10+ years			
<b>Terminations</b>	Standard 0.250" [6.4mm] spades			
<b>Approvals</b>	UL & cUL recognized (file # ELIY2.E36690), CE, SAE, NEMA 4/4X/IP66 compliant			
<b>Environmental</b>	Operating Temp.: -10°C to +60°C [14°F to +140°F] Storage Temp.: -20°C to +70°C [-4°F to +158°F] Humidity: 95% RH per SAE J1378 Shock: 44 to 55g's per SAE J1378 Dielectric: 1000VAC 50/60 Hz for 1 minute (34x0 only) Compliance: Compliant to the European WEEE and RoHS Directives Protection Against: Alternator load dump 150V EMI (Electromagnetic Interface) +400V @ 500Hz inductive switching and reverse polarity (34x0 only)			
<b>EMC Compliance</b>	EN61326			
<b>Enclosure</b>	NEMA 4/4X, 12 & IP66 compliant from the front when properly mounted using the optional gasket. (Not applicable in the Snap-In Model)			
<b>Weight</b>	1 oz. [28g]			
<b>Reset Options</b>	34xx-xx0x - Non Reset 34xx-xx1x - Remote Reset / Dry Contact (switch) 34xx-GATE - Non Reset / Optional Remote Reset			

## 3400 (Totalizer) Specification

<b>Display</b>	8 digits (99999999)
<b>Max pulse rate</b>	40 pulses per second (Hz)

## 3410 (Hour Meter) Specification

<b>Display</b>	9999999.9 (hours & 1/10's)
<b>Run Indicator</b>	Blinking decimal point
<b>Accuracy</b>	± 0.1% @ room temperature ± 0.2% over the specified temperature range

## 3400-GATE (Delayed Totalizer) Specification

<b>Display</b>	8 digits (99999999)
<b>Input Time</b>	>5 seconds to register count

## Dimensions

(All dimensions are nominal)

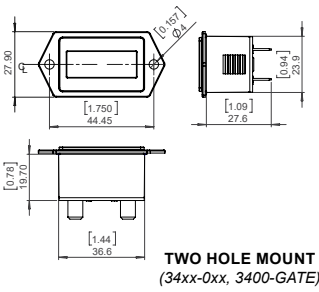

**TWO HOLE MOUNT**  
(34xx-0xx, 3400-GATE)

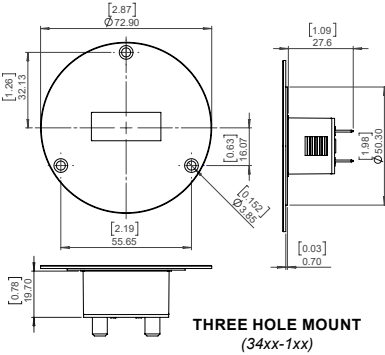

**THREE HOLE MOUNT**  
(34xx-1xx)

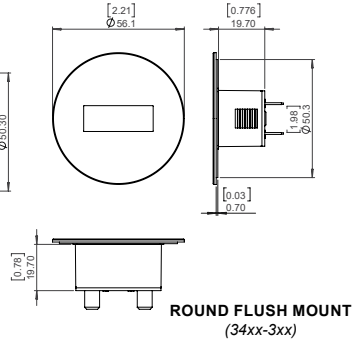

**ROUND FLUSH MOUNT**  
(34xx-3xx)

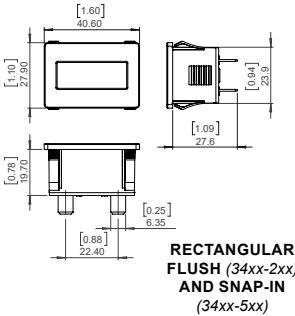

**RECTANGULAR FLUSH (34xx-2xx) AND SNAP-IN (34xx-5xx)**

## Panel Cut-out

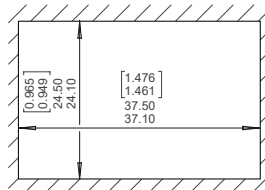

Max panel thickness, snap-in housing: .125" [3.18]  
Max panel thickness, without gasket: .375" [9.5]  
Min panel thickness, with or without gasket: .04" [1.0]

## Mounting Clip



Clip included with flush mounting models. Through hole mounting models supplied with #4 machine screws, nuts and washers.

## Gaskets (Optional)



**Gasket 5003-009**  
Max panel thickness: .275" [7.9]  
Gasket thickness: .118" [3.00]



**Gasket 5003-010**  
Max panel thickness: .275" [7.9]  
Gasket thickness: .118" [3.00]



**Gasket 5003-017**  
Max panel thickness: .313" [6.5]  
Gasket thickness: .062" [1.57]

## Wiring Diagrams

Inputs do not have a polarity and can be wired either way round.

34x3-xxxx

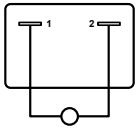

4.5-30VDC Input

34x0-xxxx

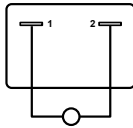

10-300VDC / 20-300VAC Input

34x1-xxxx

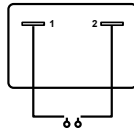

Dry Contact Input

WITH RESET (4 TERMINAL)

34xx-xx1x

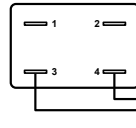

Note: Do not connect AC or DC voltages to terminals 3 or 4

34xx-GATE

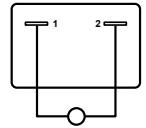

40-30VDC input



**CAUTION: RISK OF ELECTRIC SHOCK. INSTALLATION MUST BE CARRIED OUT BY SUITABLY QUALIFIED AND COMPETENT PERSONEL ONLY. HAZARDOUS VOLTAGES MAY BE PRESENT ON THE CONNECTION. THIS PRODUCT CONTAINS AN INTERNAL LITHIUM BATTERY. DISPOSE OF IN ACCORDANCE WITH LOCAL REQUIREMENTS**



### Trumeter (Europe)

Pilot Mill, Alfred Street, Bury, Lancashire  
BL9 9EF, United Kingdom  
Tel: +44 161 674 0960  
Email: sales.uk@trumeter.com

### Trumeter (Americas)

6601 Lyons Rd, SUITE H-7, Coconut Creek,  
Florida, 33073, USA  
Tel: +1 954 725 6699  
Email: sales.usa@trumeter.com

### Asia Pacific Distributor

Innovative Design Technologies Sdn. Bhd, Lot 5881,  
Lorong Iks Bukit Minyak 1  
Taman Perindustrian Iks, 14000 Bukit Tengah  
Penang, Malaysia  
Web: www.idtworld.com  
Tel: + 604 5015700  
Email: info@idtworld.com