

Process controller with PROFIBUS DP and Modbus Master/Slave 1/8 DIN - 48 x 96 mm gamma**due**[®] series X5 line

Sophisticated multifunction process controller with high level communications

By its three different kinds of serial communications:

- PROFIBUS DP Slave
- Modbus Master
- Modbus Slave,

the gamma**due**[®] X5 line can interface, on different levels, with other devices, by exchanging informations, after processing them by mathematical package. The frequency input, added to the traditional inputs, two retransmission or control analogue outputs and four programs allow you to use it for the most diversified control strategies.

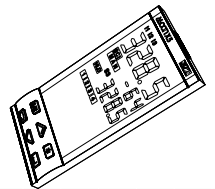
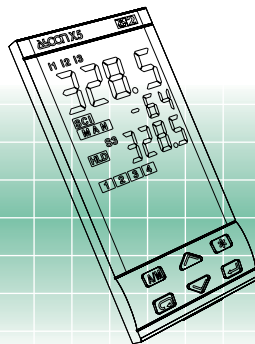
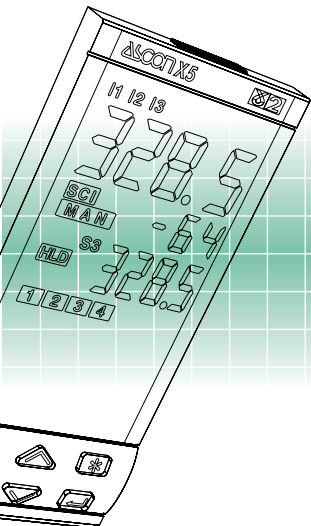

E

ISO 9001 Certified

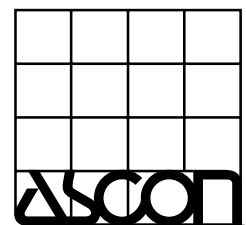

Tuning

Two methods of tuning are available:

- one shot **initial Fuzzy-Tuning**
- self-teaching **continuous Adaptive-Tuning**

Fuzzy-Tuning

Two methods of initial tuning are available:

- **Auto-Tuning "one shot"**
- **Natural frequency "one shot"**

The **Fuzzy-Tuning** automatically selects one of the two methods which assure the best result for each condition.

The **Auto-Tuning** method works best on the step response basis.

When activated, if a deviation exists between the Setpoint and process variable larger than 5% of scale range, the controller modifies the output value. Then, in a short time, it calculates the PID parameters and the new algorithm is operational immediately.

The main advantages of this method are fast calculation and quick implementation.

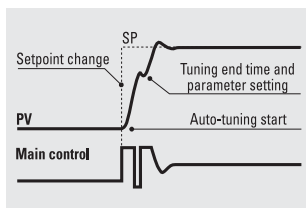

The **Natural frequency** method works best when the process variable is very near to the Setpoint. When activated, it causes a process oscillation around the Setpoint value. The main advantage of this method is a reduced disturbance to the process.

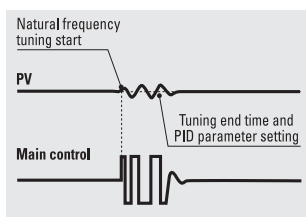

Adaptive-Tuning

It is self-teaching and waits for process change to recalculate the new PID parameters.

The new PID calculation does not influence the control output, avoiding any disturbance.

The PID optimisation is done only when necessary (e.g. Setpoint changes or process disturbances like load changes).

No action by the operator is required.

The operating mode of Adaptive-Tuning is safe and user friendly. It tests the process response after a disturbance, it memorises the intensity and frequency of the reaction, then the Adaptive-Tuning checks the new information with its statistical data base.

The correct PID algorithm is then ready to implement.

This tuning is ideal for non-linear processes where the PID parameters must be adapted to changing conditions.

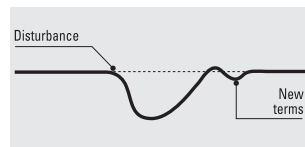

Integrity in data copy

Configuration software

A **software** tool is available to improve both the **configuration and the parameterization**.

All the data can be stored to file. It is also possible to down-load the linearisation of the "custom" input by using the polynomial's coefficients and to configure the PROFIBUS DP profile file.

Memory chip

The **memory chip** makes possible a fast and safe transfer of data related to the configuration and all parameters.

With a simple operation, the information can be stored and copied to the **memory chip**. The procedure can be protected by a password.



Setpoint programmer

Up to 4 profiles with 16 segments can be programmed. Number of cycles as well as the max. allowed deviation can be configured.

The time base can be selected from seconds, minutes and hours. Run, Hold and Stop functions can be performed by means the front keypad, by external commands or by serial communications.

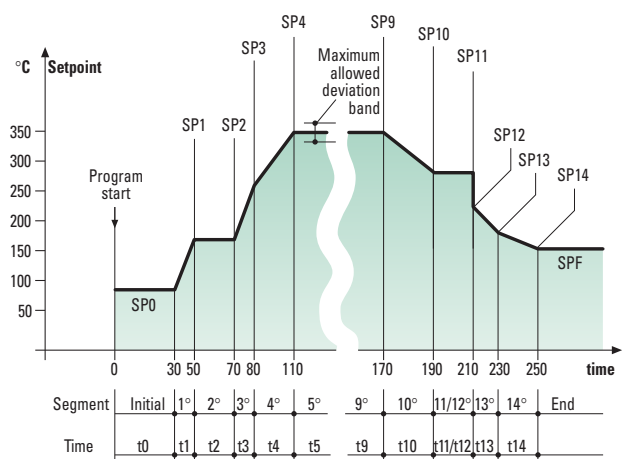

Fast view

The **Fast view** is a password protected review procedure of the 10 most useful parameters.

The combination of a luminous and comprehensive display and the ergonomic keypad allows the **immediate access** to the **Fast view**.

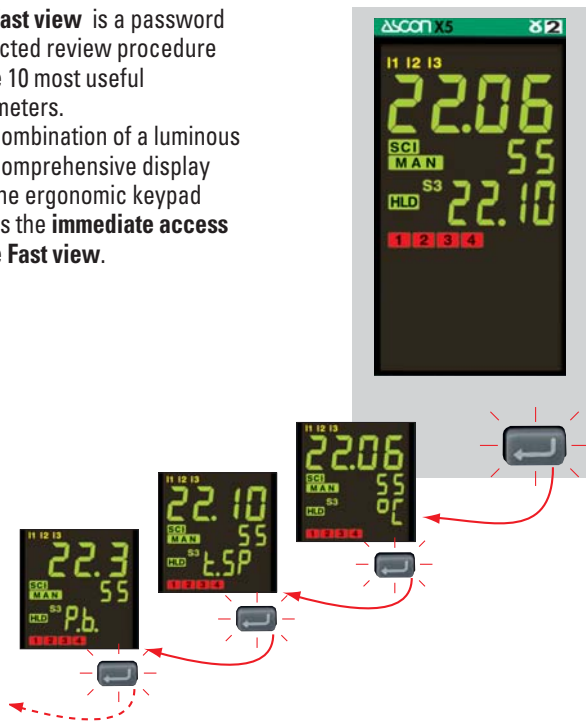

PROFIBUS DP Slave

Industrial standard for peripheral devices connection to a machine in a plant.

The protocol installed in this controller, offers the following advantages against the standard normally supplied by other suppliers:

- Communications baudrate **Up to 12 Mb/s with electric isolation**

- The list of data transfer (profile file) is **user configurable**. It can be set by means the **gammaDue®** configuration software.

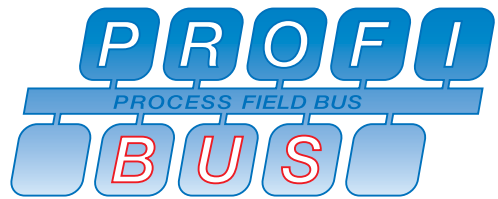

Modbus Master

Modbus serial communications allows a controller to exchange informations with other devices, **gammaDue®** series or others with Modbus Slave serial communications (PLC). For instance it is possible to read the acquired value from a **gammaDue®** C1 indicator with alarms and send this value as remote Setpoint to a **gammaDue®** X3 controller; or the **gammaDue®** X5 controller can send the Setpoint profile of the running program to many X1 controllers without Setpoint programmer function. An X5 controller can realize a

simple network for the low level data management. The X5 can also reduce the work of the SCADA and grant the exchange of data in case of its failure.

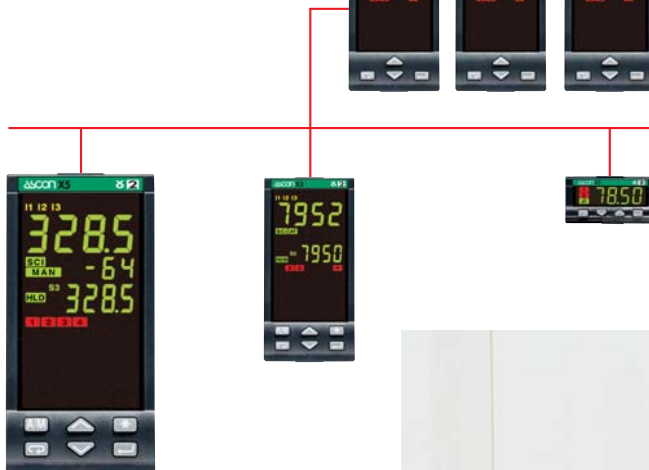

The **mathematical package** is able to process any information

there is in the controller by using a simple set of mathematical operations. For instance it can compare two values by selecting higher or lower, to do the sum or the ratio and so on. **Together with Modbus Master**, it becomes a very powerful information handler;

it can, for example, send to different controllers the same Setpoint profile with different values for every controller.

AutoLink

Self-configuring supervision software. Major features include monitoring and control of the connected devices, the visualisation by means of instrument faceplates, trend and mimic pages, data archiving as well as report generation. A self-configuring tool automatically polls the connected devices and build up the application software, reducing the start-up costs.

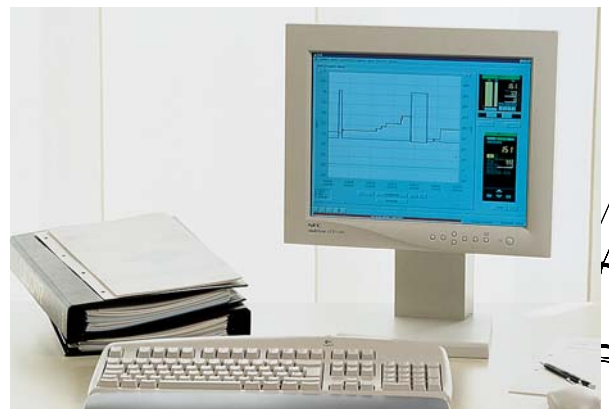



gammadue®

the right solution to your needs

Your needs	Our solutions
High speed data acquisition and signal management	Sampling time: 100 ms measure update time: 50 ms
Use of different actuators	Two analogue outputs, heat/cool (linear, water, oil), valve control output with potentiometer position feedback
Process with time variable characteristic	Two initial and one continuous calculations of the right control parameters
Alarm signalling and diagnostic	Absolute, band and deviation alarm, Latching/Blocking, loop break alarm
Interfacing with other devices	Serial communications at 19,200 baud Modbus/Jbus Master and Slave, PROFIBUS DP at 12 Mbaud, two retransmission outputs, Remote Setpoint input, three digital inputs
Temperature profile	4 program with 16 segments, 3 stored Setpoints
Safe and reproducible configuration and parameter settings	Memory chip for data transfer and storing, configuration and parameterisation software
Environmental protection	IP65 front panel protection (indoor, dust and water protection)
Noise immunity	Electromagnetic compatibility
Universal input signals, linear as well as non-linear	Configurable input (TC, RTD, mA, Volt and ΔT, infrared sensor, "custom" linearisation, frequency input up to 20 kHz)
Reliability and safety	CE compatibility, ASCON is ISO 9001 certified, 3 years warranty
Technical support	Technical application assistance from ASCON sales and after sales service

Resources Operating mode

Resources

Memory Chip
Data Copy/Data Store (option)

Main universal input (option)
12 TC, Pt100, ΔT, mA V, Custom, Hz, PV

Auxiliary input
REM mA, REM V, POT. → AUX

Three digital inputs
→ IL1, IL2, IL3

Setpoint
LOC, 3 MEM, REM, 4x16s

IL1, IL2 or IL3 connected functions
MEM, REM, RUN, HOLD PV, SP SCORE

Modbus RS485 Master
Link to other instruments (option)

Modbus RS485 Slave
Parameterisation, Supervision (option)

Operating mode

	Control	Alarms	Retransmission
			PV/SP
1	Single action	OP1	OP2 OP3 OP4 OP5 OP6
2		OP5	OP1 OP2 OP3 OP4 OP6
3	Double action	OP1 OP2	OP3 OP4 OP5 OP6
4		OP1 OP5	OP2 OP3 OP4 OP6
5		OP5 OP2	OP1 OP3 OP4 OP6
6		OP5 OP6	OP1 OP2 OP3 OP4
7	Valve	OP1 OP2	OP3 OP4 OP5 OP6

Fuzzy tuning with automatic selection
One shot Auto tuning, One shot Natural Frequency

Continuous tuning
Adaptive

PROFIBUS
PROCESS FIELD BUS

Technical data

Features (at 25°C T. env. amb.)	Description			
Total configurability	From keypad or serial communication the user selects: - the type of input - the type of Setpoint - the type of control algorithm - the type of output - the type and functionality of the alarms - control parameter values - access levels			
PV input (for signal ranges see table 1)	Common characteristics	A/D converter with resolution of 160000 points Update measurement time: 50 ms Sampling time (max. update time of the output adjustable): 0.1...10.0 s. Configurable - Input shift: - 60...+ 60 digit Input filter with enable/disable: 0.1...999.9 seconds		
	Accuracy	0.25% ±1 digits for temperature sensors 0.1% ±1 digits (for mV and mA)	Between 100...240 Vac the error is minimal	
	Resistance thermometer (for ΔT: R1+R2 must be <320Ω)	Pt100Ω at 0°C (IEC 751) °C/°F selectable	2 or 3 wires connection Burnout (with any combination)	Max. wire Res.: 20Ω max. (3 wires) Sensitivity: 0.1°C/10°C Env T. <0.1°C/10Ω Wire Res.
	Thermocouple	L, J, T, K, S, R, B, N, E, W3, W5 (IEC 584) Rj >10MΩ °C/°F selectable	Internal cold junction compensation with NTC Error 1°C/20°C ± 0.5°C Burnout	Line: 150Ω max. Input drift: <2μV/10Ω Env T. <5μV/10Ω Wire Res.
	DC input (current)	4/0...20mA Rj >30Ω 0...50mV, 0...300mV	Burnout. Engineering units, conf. decimal point	Input drift: <0.1% / 20°C Env. Temp. <5μV/10Ω Wire Res.
	DC input (voltage)	Rj >10MΩ 1...5, 0...5, 0...10V Rj >10kΩ	position with or without √ I. Sc.: -999...9,999	
	Frequency (option) 0...2/0...20kHz	Low level ≤2V High level 4...24V	F. Sc.: -999...9,999 (min. range of 100 digit)	
Auxiliary inputs	Remote Setpoint not isolated accuracy 0.1%	Current 0/4...20mA Rj = 30Ω Voltage 1...5, 0...5, 0...10V Rj = 300kΩ	Bias in engineering units and ±range Ratio from -9.99...+99.99 Local + Remote Setpoint	
	Potentiometer	100Ω...10kΩ	Feedback valve position	
Digital inputs 3 logic	The closure of an external contact performs: Auto/Man mode change, Local/Remote Setpoint mode change, 3 Stored Setpoint activation, keyboard lock, measure hold, slope inhibit and output forcing Program run/hold and selection (if option installed)			
Operating mode and Outputs	1 single or double action P.I.D. loop or On/Off with 1, 2, 3 or 4 alarms			
Control mode	Algorithm	P.I.D. with overshoot control or On/Off algorithms, valve P.I.D. algorithm to control motorised positioners		
	Proportional band (P)	0.5...999.9%		
	Integral time (I)	1...9,999 s	enabled disabled	
	Derivative time (D)	0.1...999.9 s		
	Error dead band	0.1...10.0 digit		
	Overshoot control	0.01...1.00		
	Manual reset	0...100%		
	Cycle time (Time proportional only)	0.2...100.0 s		
	Min./Max. output limits	0...100% separately adjustable		
	Control output rate limit	0.01...99.99%/s		
	Soft-start output value	1...100% time 1...9,999 s	enabled disabled	
	Output safety value	-100...100%		
	Control output forcing value	-100...100%		
	Control output hysteresis	0...5% Span in engineering units		
	Dead band	0.0...5.0%		
	Cool proportional band (P)	0.5...999.9%		
Cool integral time (I)	1...9,999 s	enabled disabled		
Cool derivative time (D)	0.1...9,999 s			
Cool cycle time (Time proportional only)	0.2...100.0 s			
Cool control output high limit	0...100%			
Cool output max. rate	0.01...99.99/s			

Input type	Scale range
RTD Pt100 IEC751	-99.9...300.0 °C
	-99.9...572.0 °F
	-200...600 °C -328...1112 °F
RTD 2xPt100 IEC751 per ΔT	-50.0...50.0 °C
	-58.0...122.0 °F
TC L Fe-Const DIN43710	0...600 °C 32...1,112 °F
TC J Fe-CU45% NI IEC584	0...600 °C 32...1,112 °F
TC T Cu-CuNi IEC584	-200...400 °C -328...752 °F
TC K Chromel-Alumel IEC584	0...1,200 °C 32...2,192 °F
TC S Pt10% Rh Pt IEC584	0...1,600 °C 32...2,912 °F
TC R Pt13% Rh Pt IEC584	0...1,600 °C 32...2,912 °F
TC B Pt30% Rh Pt 6% IEC584	0...1,800 °C 32...3,272 °F
TC N Nichrosil-Nisil IEC584	0...1,200 °C 32...2,192 °F
TC E Ni10% CR CuNi IEC584	0...600 °C 32...1,112 °F
TC NI-NiMo18%	0...1,100 °C 32...2,012 °F
TC D W3%Re 25%Re IEC584	0...2,000 °C 32...3,632 °F
TC C W5%Re W26%Re IEC584	0...2,000 °C 32...3,632 °F
0/4...20 mA 0...50/300 mV 0/1...5 V 0...10 V	Configurable engineering units mA, mV, V, bar, psi, Rh, ph
Custom scale	On request
Frequency (option)	0...2KHz or 0...20KHz

Table 1: PV input

Technical data

Features (at 25°C T. env. amb.)	Description		
Control mode	Motor travel time	15...600 s	Valve drive PID algorithm
	Motor minimum step	0.1...5.0%	
	Feedback potentiometer	100Ω...10kΩ	
OP1-OP2 outputs	SPST relay N.O., 2A/250Vac (4A/120Vac) for resistive load Triac, 1A/250Vac for resistive load		
OP3 output	SPDT relay N.O., 2A/250Vac (4A/120Vac) for resistive load		
OP4 output	SPST relay N.O., 2A/250Vac (4A/120Vac) for resistive load		
Analogue / digital OP5 and OP6 (option) outputs	Control retransmission of PV/SP	Galvanic isolation: 500Vac/1 min. Short circuit protected Resolution 12 bit Accuracy: 0.1%	Analogue: 0/1...5V, 0...10V, 500Ω/20mA max. 0/4...20mA, 750Ω/15V max. Digital: 0/24Vdc ±10% - 30mA max. for solid state relay
		Hysteresis 0...5% Span in engineering units	
AL1 - AL2 - AL3 AL4 alarms	Action	Active high	Deviation threshold ±range
		Active low	Action type
		Special functions	Band threshold 0...range
			Absolute threshold whole range
Sensor break, heater break alarm Acknowledge (latching), activation inhibit (blocking) OP3, OP4 connected to Timer or Program (if option installed)			
Setpoint	Local + 3 stored	Up and down ramps 0.1...999.9 digit/min or digit/h (OFF=0) Low limit: from low range to high limit Remote Setpoint not available with frequency input	
	Remote only		
	Local and Remote		
	Local with trim		
	Remote with trim		
Programmable	If option installed		
Programmable Setpoint (optional)	4 programs, 16 segments (1 initial and 1 end) From 1 to 9999 cycles or continuous cycling (OFF) Time values in seconds, minutes and hours Start, stop, hold, etc. activated from the keypad, digital input and serial line		
	Fuzzy-Tuning type. The controller selects automatically the best method according to the process conditions		
	Step response Natural frequency		
Tuning	Adaptive Tune self-learning, not intrusive, analysis of the process response to perturbations and continuous calculation of the PID parameters		
	Auto/Man selection Standard with bumpless function, by keypad, digital or serial communications		
Serial comm.s (option)	RS 485 isolated, SLAVE Modbus/Jbus protocol, 1,200, 2,400, 4,800, 9,600, 19,200 bit/s 3 wires		
	RS 485 isolated, MASTER Modbus/Jbus protocol, 1,200, 2,400, 4,800, 9,600, 19,200 bit/s 3 wires		
	RS485 asynchronous / isolated, PROFIBUS DP protocol, from 9,600 bit/s at 12MB/s selectable, max. length 100 m (at 12 Mb/s.)		
Auxiliary supply	+24Vdc ± 20% 30mA max. - for external transmitter supply		
Operation alarm safety	Measure input	Detection of out of range, short circuit or sensor break with automatic activation of the safety strategies and alerts on display	
	Control output	Safety and forcing value separately adjustable: -100...100%	
	Parameters	Parameter and configuration data are stored in a non volatile memory for an unlimited time	
	Access protection	Password to access the configuration and parameters data Fast view	
General characteristics	Power supply (fuse protected)	100...240Vac (-15...+10%) 50/60Hz or 24Vac (-25...+12%) 50/60Hz and 24Vdc (-15...+25%)	Power consumption 5W max.
	Safety	Compliance to EN61010-1 (IEC1010-1), installation class 2 (2.5kV) pollution class 2, instrument class II	
	Electromagnetic compatibility	Compliance to the CE standards	
	UL and cUL Approval	File E176452	
	Protection EN60529 (IEC529)	IP65 front panel	
Dimensions	1/8 DIN - 48 x 96, depth 110 mm, weight 380 g apx.		

Electrical wirings

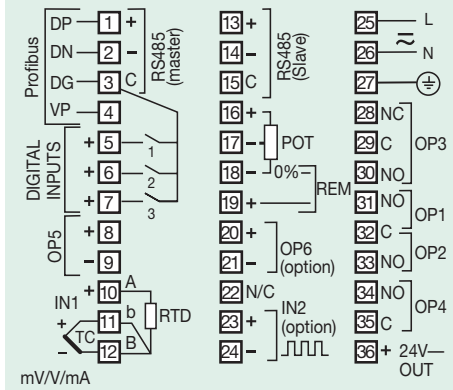

Dimensions

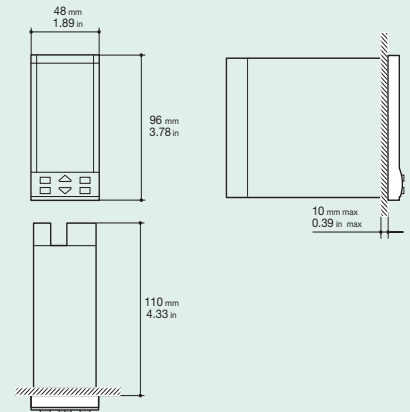

Panel cut-out

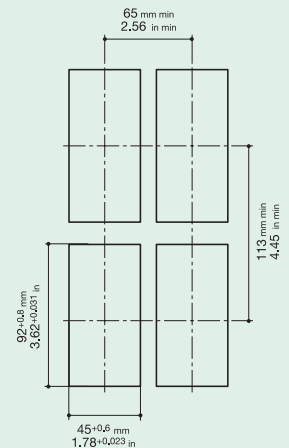

Ordering codes

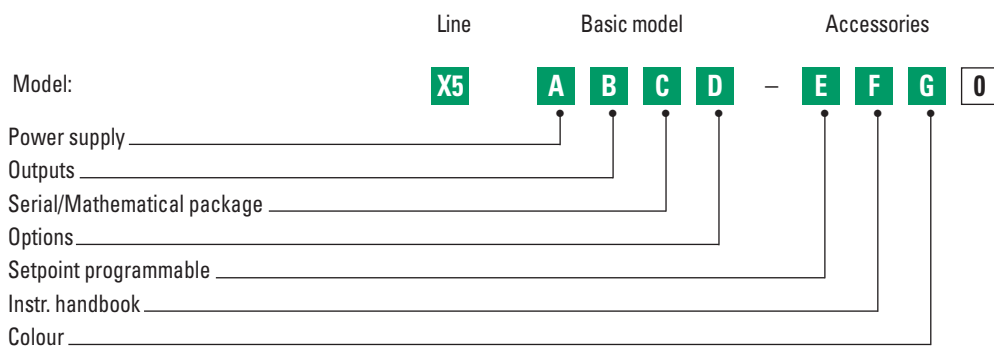

Power supply	A
100...240Vac (-15...+10%)	3
24Vac (-25...+12%) or 24Vdc (-15...+25%)	5
OP1-OP2 outputs	B
Relay-Relay	1
Triac-Triac	5
Serial communications/Mathematical package	C
Not fitted	0
Mathematical package	1
RS 485 Modbus/Jbus SLAVE + Mathematical package	5
RS 485 Modbus/Jbus SLAVE+MASTER + Mathematical package	6
PROFIBUS DP SLAVE + Mathematical package	7
RS 485 Modbus/Jbus SLAVE+PROFIBUS DP SLAVE + Mathematical package	8
Options	D
None	0
Frequency input (Remote Setpoint not available)	1
Second analogue/digital output (OP6)	4
Frequency input + second analogue output (OP6) (Remote Setpoint not available)	6
Setpoint programmer	E
Not fitted	0
Four "16 segments" programs	4
Instruction handbook	F
Italian-English (std)	0
French-English	1
German-English	2
Spanish-English	3
Front case colour	G
Dark (std)	0
Beige	1

If not differently specified the controller will be supplied with standard version
Model: X5 3100-0000



S E R I E S

ASCON spa

Via Falzarego, 9/11
20021 Baranzate
(Milano) Italy
Tel. +39 02 333 371
Fax +39 02 350 4243
<http://www.ascon.it>
sales@ascon.it

ASCON FRANCE

2 bis, Rue Paul Henri Spaak
ST. THIBAUT DES VIGNES
F-77462 LAGNY SUR
MARNE - Cedex
Tél. +33 (0) 1 64 30 62 62
Fax +33 (0) 1 64 30 84 98
ascon.france@wanadoo.fr

AGENCE EST

Tél. +33 (3) 89 76 99 89
Fax +33 (3) 89 76 87 03

AGENCE SUD-EST

Tél. +33 (0) 4 74 27 82 81
Fax +33 (0) 4 74 27 81 71

ASCON CORPORATION

472 Ridgelawn Trail
Batavia, Illinois 60510
Tél. +1 630 482 2950
Fax +1 630 482 2956
www.asconcorp.com
info@asconcorp.com

WORLDWIDE NETWORK OF DIRECT SALES CENTERS, DISTRIBUTORS AND VARs

Europe

Belgium, Croatia, Czech Rep.,
Denmark, Esthonia, Finland, France,
Germany, Great Britain, Greece,
Holland, Ireland, Norway, Poland,
Portugal, Romania, Russia, Slovakia,
Slovenia, Spain, Sweden, Switzerland,
Turkey, Ukraine

Americas

Argentina, Brazil, Canada, Chile,
Colombia, Ecuador, Mexico, Paraguay,
Peru, Uruguay, Venezuela

Rest of the world

Algeria, Australia, China, Egypt,
Hong Kong, India, Indonesia, Iran,
Israel, Malaysia, Morocco, New
Zeland, Pakistan, Saudi Arabia,
Singapore, Taiwan, Thailand, Tunisia,
South Africa & South East Africa,
UAE

