

ASCON spa
ISO 9001
Certified

ASCON spa
20021 Baranzate
(Milan) Italy
via Falzarego, 9/11
Fax +39 02 350 4243
<http://www.ascon.it>
e-mail support@ascon.it

Process controller with PROFIBUS DP and Modbus Master/Slave

1/4 DIN - 96 x 96

Q5 line

User manual • M.I.U.Q5 -2/04.05 • Cod. J30-478-1AQ5 IE



Process controller with PROFIBUS DP and Modbus Master/Slave

1/4 DIN - 96 x 96

Q5 line

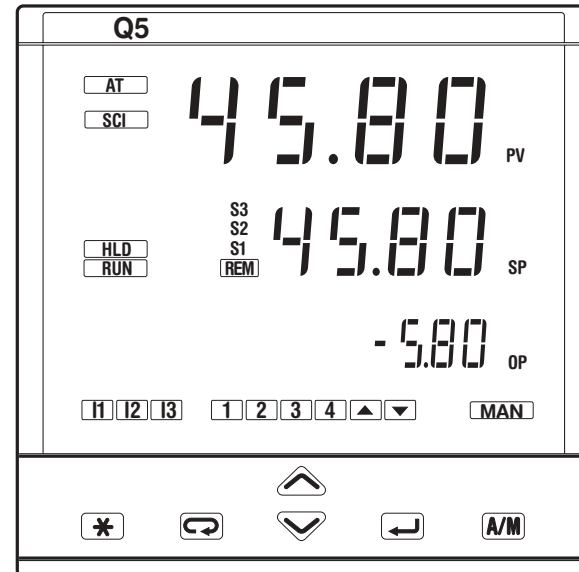



NOTES

ON ELECTRIC SAFETY AND ELECTROMAGNETIC COMPATIBILITY

Please, read carefully these instructions before proceeding with the installation of the controller.

Class II instrument, for indoor use only.

This controller has been designed with compliance to:

Regulations on electrical apparatus (appliance, systems and installations) according to the European Community directive 73/23/EEC amended by the European Community directive 93/68/EEC and the Regulations on the essential protection requirements in electrical apparatus EN61010-1: 93 + A2: 95.

Regulations on Electromagnetic Compatibility according to the European Community directive n° 89/336/EEC, amended by the European Community directive n° 92/31/EEC, 93/68/EEC, 98/13/EEC and the following regulations:

- *Regulations on RF emissions:*

EN61000-6-3: 2001 residential environments

EN61000-6-4: 2001 industrial environments

- *Regulation on RF immunity:*

EN61000-6-2: 2001 industrial equipment and system

It is important to understand that it's responsibility of the installer to ensure the compliance of the regulations on safety requirements and EMC.

Repairs: this device has no user serviceable parts and requires special equipment and specialised engineers. Therefore, a repair can be hardly carried on directly by the user. For this purpose, the manufacturer provides technical assistance and the repair service for its Customers. Please, contact your nearest Agent for further information.

All the information and warnings about safety and electromagnetic compatibility are marked with the  sign, at the side of the note.

TABLE OF CONTENTS

1	INTRODUCTION	page 4	5	DISPLAYS	page 53
	1.1 PRODUCT CODING	page 5			
2	INSTALLATION	page 6	6	COMMANDS	page 54
	2.1 DESCRIPTION	page 6		6.1 COMMANDS FROM KEYBOARD	page 55
	2.2 OPERATING CONDITIONS	page 8		6.2 COMMANDS FROM DIGITAL INPUTS	page 58
	2.3 INSTALLATION	page 9		6.3 COMMANDS FROM SERIAL COMMUNICATION (PLEASE, REFER THE ADDENDUM ON THE SERIAL COMMUNICATION)	
3	ELECTRICAL CONNECTIONS	page 10	7	SETPOINT PROGRAMMER (OPTIONAL)	page 59
	3.1 TERMINATION UNIT	page 10		7.1 PROGRAM ORGANISATION	page 59
	3.2 CABLING LAYOUT	page 11		7.2 OPERATING CONDITIONS	page 60
	3.3 EXAMPLE OF WIRING DIAGRAM	page 12		7.3 PARAMETERISATION - PROGRAM MENU	page 62
4	OPERATIONS	page 22		7.4 PROGRAM STATUS DISPLAYING	page 64
	4.1 KEYS FUNCTIONS AND DISPLAY	page 22		7.5 RUN/STOP OF A PROGRAM	page 65
	4.2 DATA SETTING	page 24	8	TECHNICAL SPECIFICATIONS	page 69
	4.3 CONFIGURATION	page 25			
	4.4 PARAMETERISATION	page 34			
	4.5 PARAMETERS	page 42			
	4.6 ACCESS LEVELS	page 50			

1 INTRODUCTION

POWERFUL FEATURES AND A WIDE RANGE OF FUNCTIONALITIES

Congratulations for having chosen these universal controllers. They are the best result of our experience in designing and manufacturing of smart, powerful and high reliable controllers.

The process controllers of the Q5 series have been designed for the industrial environment, are provided with a complete set of functions, as a true universal instrument.

They can be used as Controllers-Programmers with 4 Setpoint profiles of 16 segments.

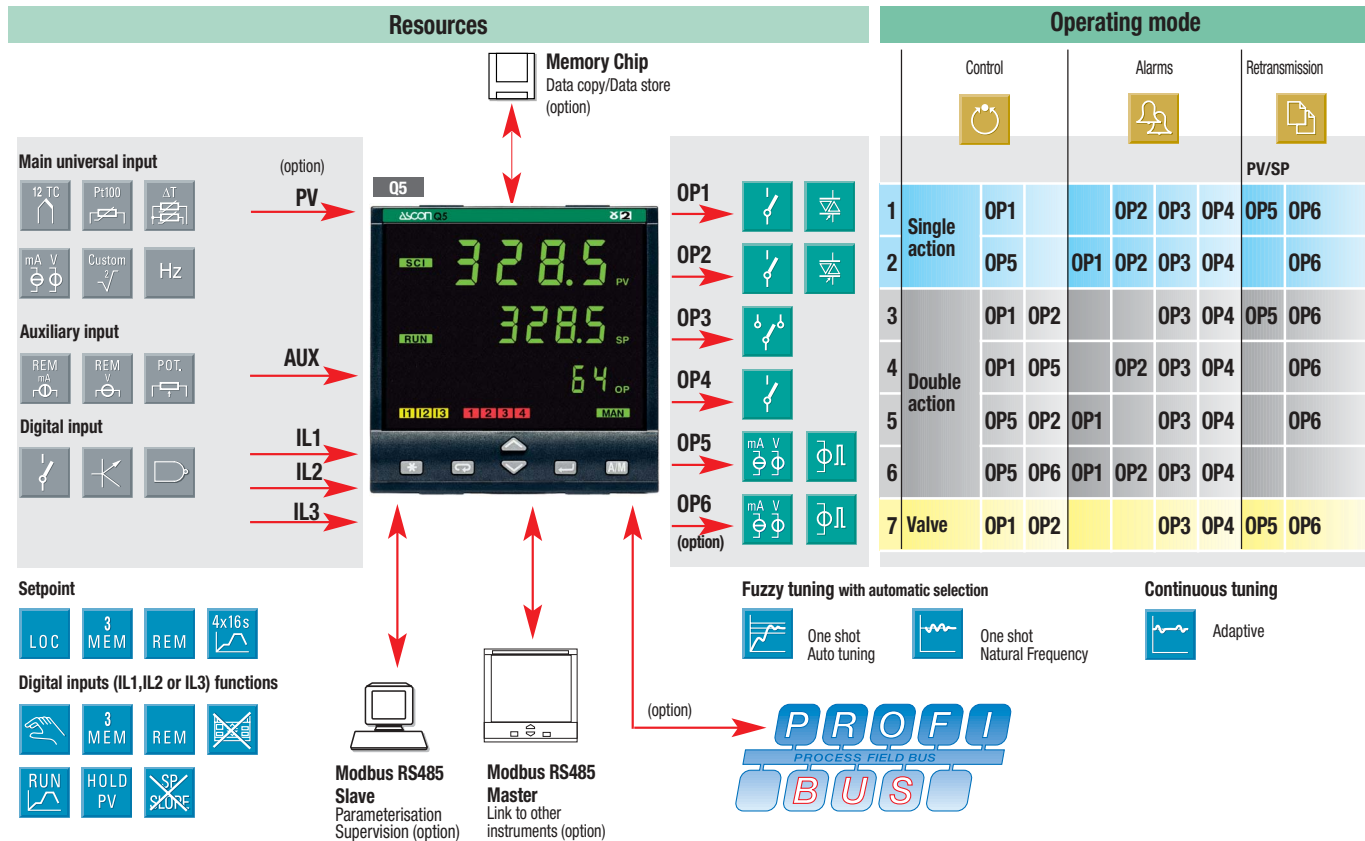

1.1 MODEL CODE

The complete code is displayed on the instrument label.

The information about product coding are accessible from the front panel by mean of a particular procedure described at section 5.1 page 53.

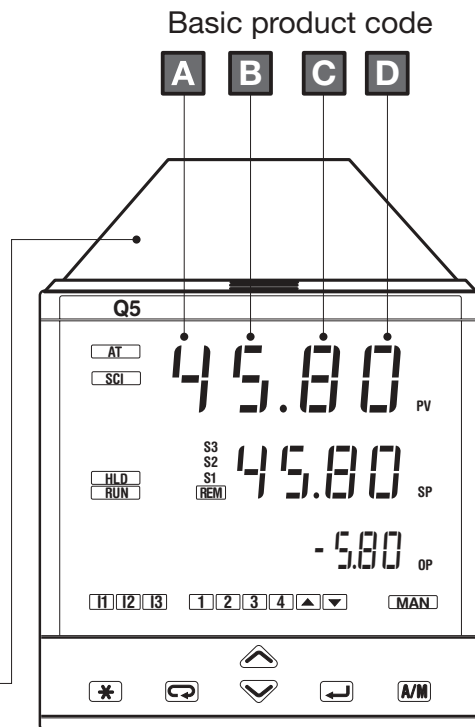

Instrument label

P/N : Q5-3150-0000
 CONF :
 S/N : A0A-9919/0013
 V~(L-N) : 100÷240V 50/60 Hz - 5W

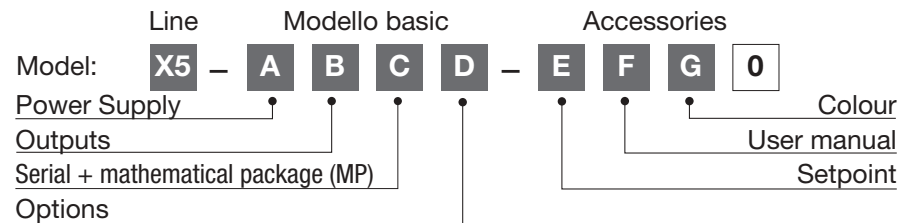

Power supply	A
100...240Vac (-15...10%)	3
24Vac (-25...+12%) or 24Vdc (-15...+25%)	5

Outputs OP1 - OP2	B
Relay - Relay	1
Triac - Triac	5

Serial Communications	C
None	0
Mathematical package (MP)	1
RS485 Modbus/Jbus SLAVE + MP	5
RS485 Modbus/Jbus SLAVE + MASTER + MP	6
PROFIBUS DP SLAVE + MP	7
RS485 Modbus/Jbus SLAVE + PROFIBUS + MP	8

Options	D
None	0
Frequency input	1
2 nd SSR drive/analogue output (OP6)	4
Frequency input + OP6	6

Setpoint Programmer	E
Not fitted	0
4 programs with 16 segments	4

User manual	F
Italian/English (std.)	0
French/English	1
German/English	2
Spanish/English	3

Front panel colour	G
Dark (std.)	0
Beige	1

2 INSTALLATION

Installation must only be carried out by qualified personnel.

Before proceeding with the installation of this controller, follow the instructions illustrated in this manual and, particularly the installation precautions marked with the  symbol, related to the European Community directive on electrical protection and electromagnetic compatibility.



To prevent hands or metal touching parts that may be electrically live, **the controllers must be installed in an enclosure and/or in a cubicle.**

2.1 GENERAL DESCRIPTION

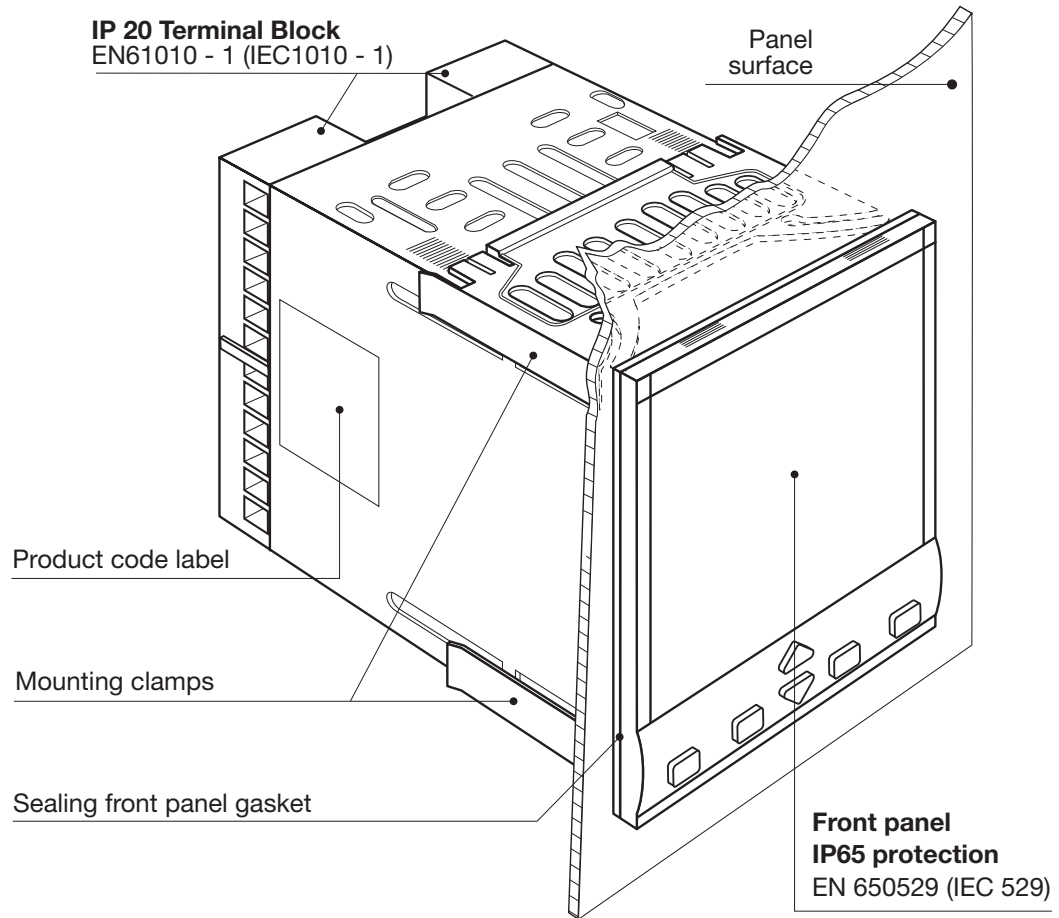

2.1.1 DIMENSIONAL DETAILS

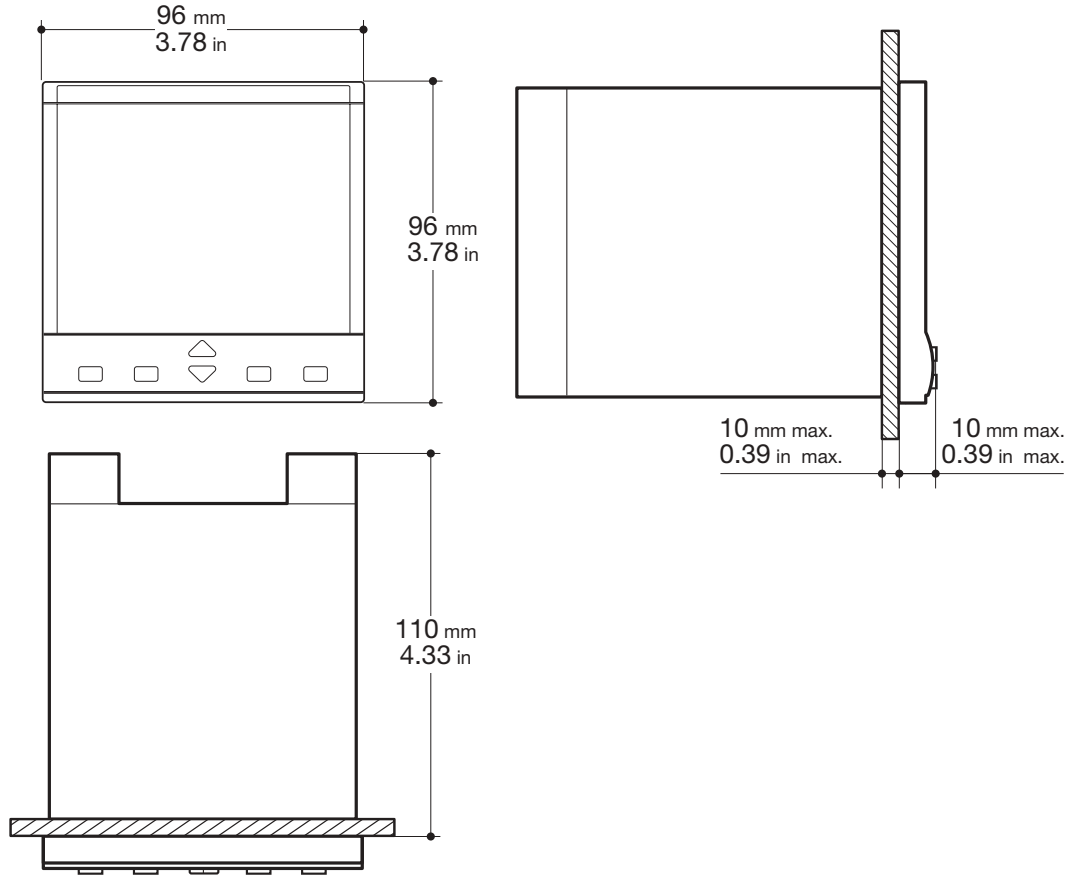

2.1.2 PANEL CUT-OUT

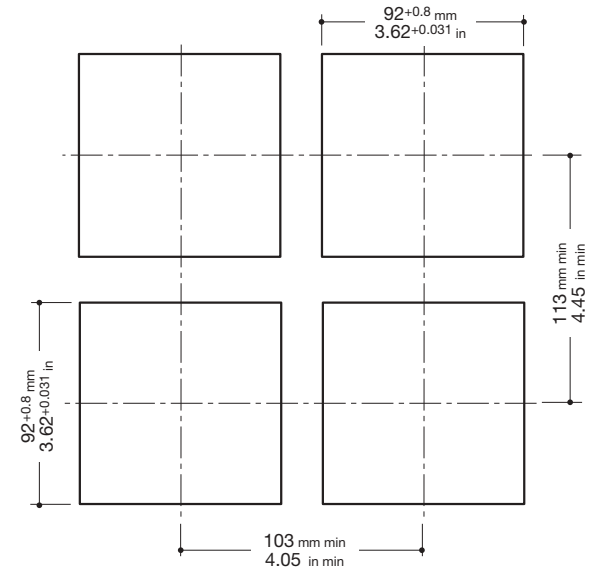

2.2 ENVIRONMENTAL RATINGS



Operating conditions



Altitude up to 2000 m



Temperature 0...50°C

%Rh

Relative humidity 5...95 % non-condensing

Special conditions

Suggestions



Altitude > 2,000 m

Use 24Vac supply version



Temperature >50°C

Use forced air ventilation

%Rh

Humidity > 95 %

Warm up



Conducting atmosphere

Use filter

Forbidden Conditions



Corrosive atmosphere



Explosive atmosphere

2.3 PANEL MOUNTING [1]

2.3.1 INSERT THE INSTRUMENT

- 1 Prepare panel cut-out;
- 2 Check front panel gasket position;
- 3 Insert the instrument through the cut-out.

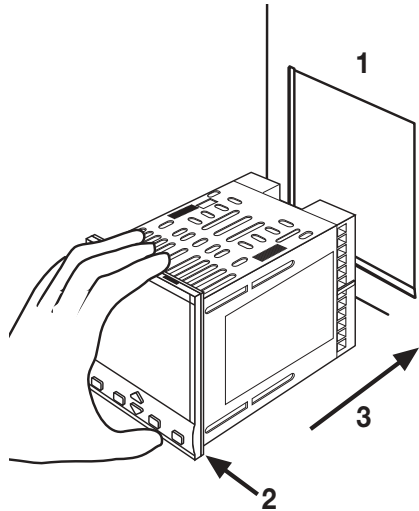

UL note

[1] For Use on a Flat Surface of a Type 2 and Type 3 'raintight' Enclosure.

2.3.2 INSTALLATION SECURING

- 1 Fit the mounting clamps;
- 2 Push the mounting clamps towards the panel surface to secure the instrument

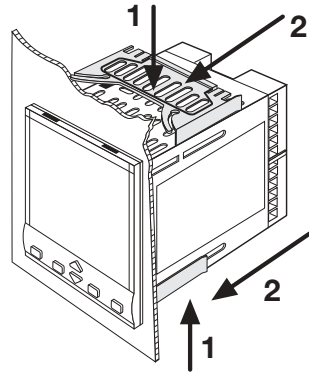

2.3.3 CLAMPS REMOVING

- 1 Insert the screwdriver in the clips of the clamps;
- 2 Rotate the screwdriver.

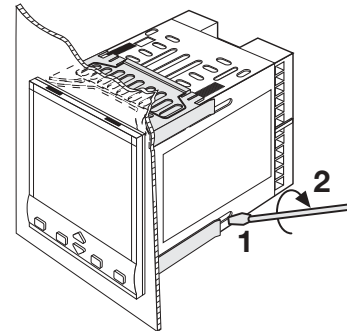

2.3.4 INSTRUMENT UNPLUGGING



- 1 Push and
- 2 Pull to remove the instrument.

Electrostatic discharges can damage the instrument.



Before removing the instrument the operator must discharge himself to ground.

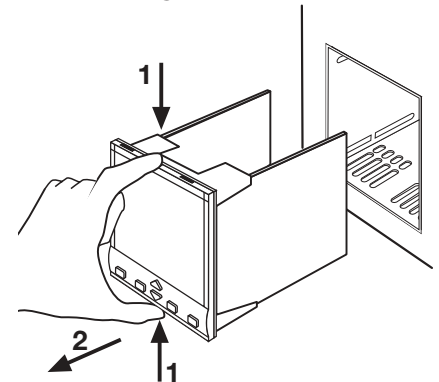

3 ELECTRICAL CONNECTIONS

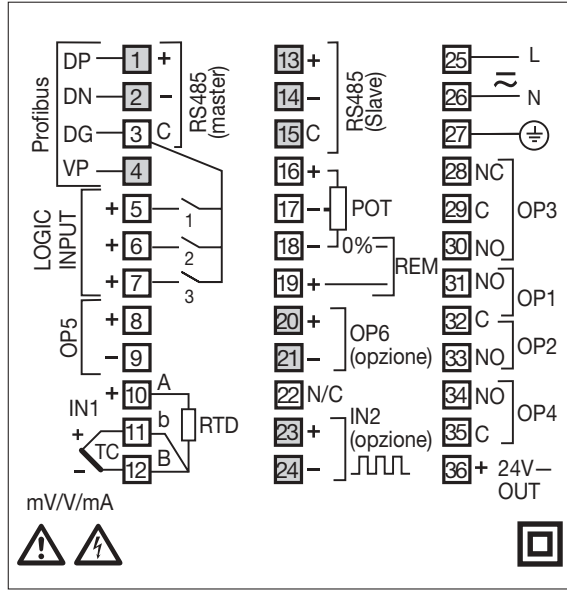

UL note

- [1] Use 60/70 °C copper (Cu) conductor only.
- [2] Wire size 1mm² (18 AWG Solid/Stranded).

3.1 TERMINATION UNIT [1]

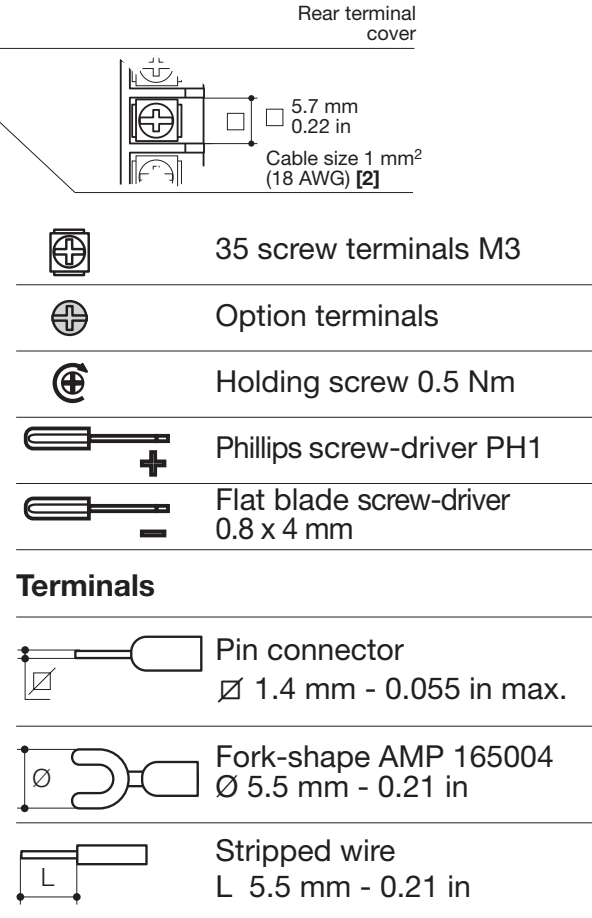
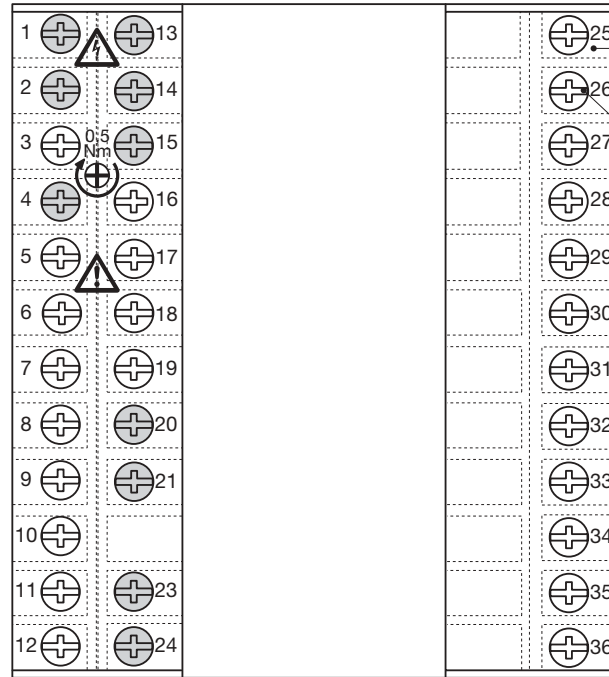

PRECAUTIONS

Despite the fact that the instrument has been designed to work in an harsh and noisy environmental (level IV of the industrial standard IEC 801-4), it is recommended to follow the following suggestions.



All the wiring must comply with the local regulations. The supply wiring should be routed away from the power cables. Avoid to use electromagnetic contactors, power Relays and high power motors nearby. Avoid power units nearby, especially if controlled in phase angle.

Keep the low level sensor input wires away from the power lines and the output cables. If this is not achievable, use shielded cables on the sensor input, with the shield connected to earth.

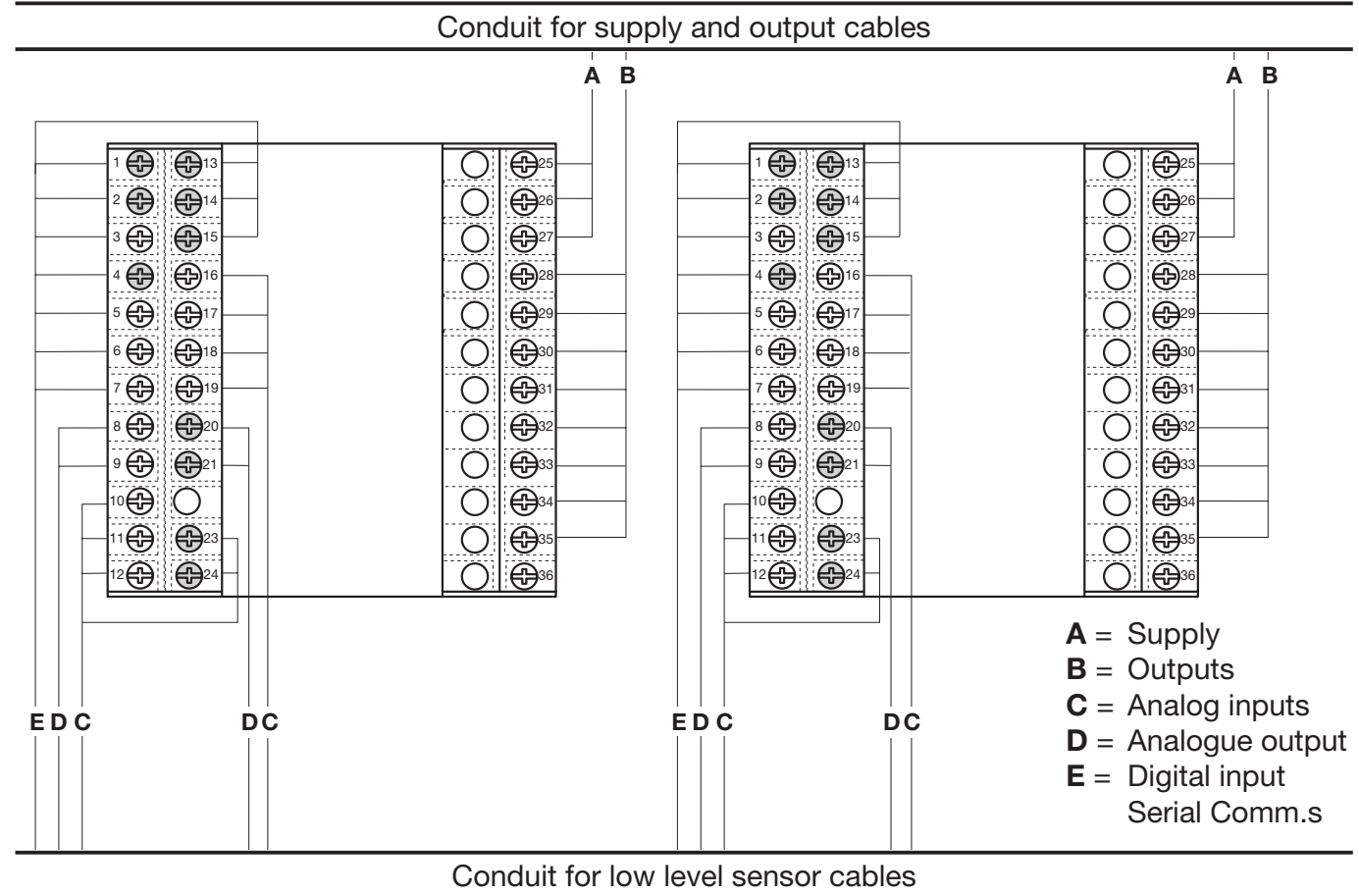
3.2 SUGGESTED WIRE ROUTING

3.3 EXAMPLE OF WIRING DIAGRAM (VALVE CONTROL)

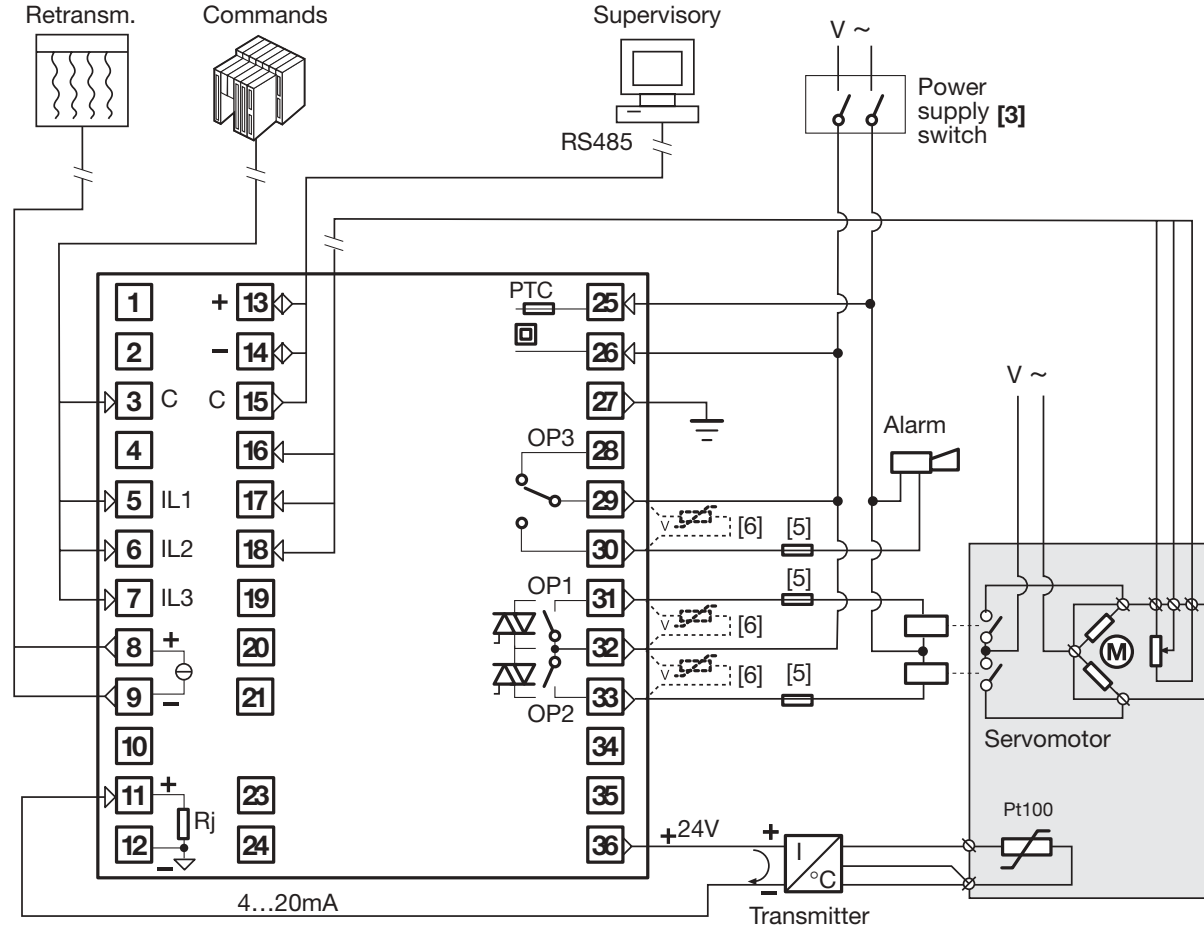
**Notes:**

- 1] Make sure that the power supply voltage is the same indicated on the instrument.
 - 2] Switch on the power supply only after that all the electrical connections have been completed.
 - 3] In accordance with the safety regulations, the power supply switch shall bring the identification of the relevant instrument. The power supply switch shall be easily accessible from the operator.
 - 4] The instrument is PTC protected. In case of failure it is suggested to return the instrument to the manufacturer for repair.
 - 5] To protect the instrument internal circuits use:
 - 2 A T fuse for Relay outputs (220 Vac);
 - 4 AT fuse for Relay outputs (110 Vac);
 - 1 AT fuse for Triac outputs.
 - 6] Relay contacts are already protected with varistors.
- Only in case of 24 Vac inductive loads, use model A51-065-30D7 varistors (on request).**

3.3.1 POWER SUPPLY

Switching power supply with multiple isolation and PTC protection.

- **Standard version:**

Nominal voltage:
100...240Vac (-15...+10%);
Frequency 50/60Hz.

- **Low Voltage version:**

Nominal voltage:
24Vac (-25...+12%);
Frequency 50/60Hz
or 24Vdc (-15...+25%).
Power consumption 5W max.

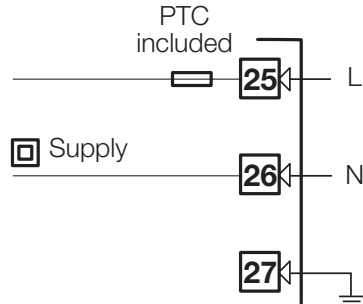

3.3.2 PV CONTROL INPUT

A L-J-K-S-R-T-B-N-E-W thermocouple type

- Connect the wires with the polarity as shown.
- Use always compensation cable of the correct type for the thermocouple used.
- The shield, if present, must be connected to a proper earth.

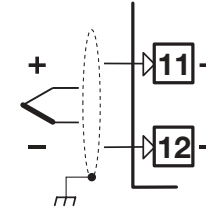

Wire resistance
150Ω max.

B For Pt100 resistance thermometer

- If a 3 wires system is used, use always cables of the same diameter (1mm² min.).
Maximum line resistance 20 Ω/lead.
- When using a 2 wires system, use always cables of the same diameter (1.5mm² min.) and put a jumper between terminals 11 and 12.

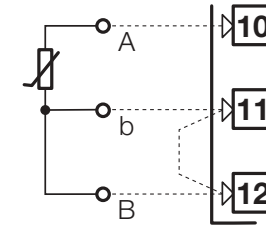

Only for two wires system, put a jumper between terminals 11 and 12.

C For ΔT (2x RTD Pt100) Special

-  When the distance between the controller and the sensor is 15m using a cable of 1.5 mm² diameter, produces an error on the measure of 1°C.

R1 + R2 must be <320Ω

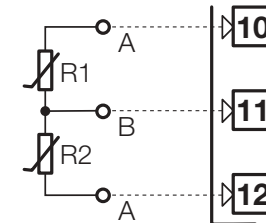

Use wires of the same length and 1.5 mm² size.
Maximum line resistance 20 Ω/line.

3.3.2 PV CONTROL INPUT



C For mA, mV and Volt

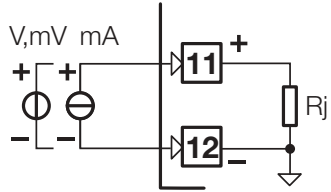

Input resistance = 30Ω for mA reading;
 Input resistance $> 10M\Omega$ for mV reading;
 Input resistance = $10k\Omega$ for Volt reading.

C1 With 2 wires transducer

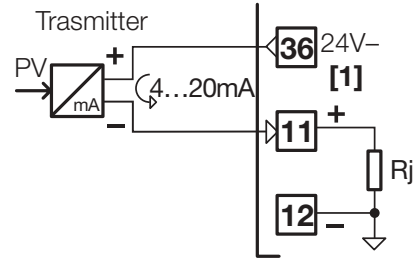

C2 With 3 wires transducer

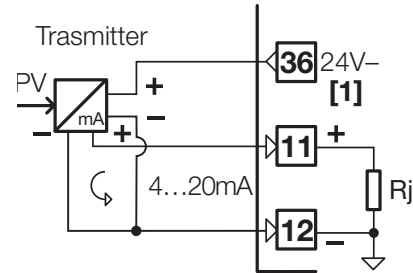

Note:

[1] Auxiliary power supply for external transmitter 24V-
 $\pm 20\%$ /30mA max. without short circuit protection.

3.3.3 PV CONTROL INPUT - IN2 FREQUENCY INPUT



Using the frequency input, the IN1 input is not yet available

- Low level: 0... 2Volt /0.5mA max.
- High level: 3... 24Volt/ ~ 0 mA max.
- Frequency range: 0... 2kHz/0... 20kHz selectable in configuration mode.
- Use sensors with an NPN output or a clean contact.

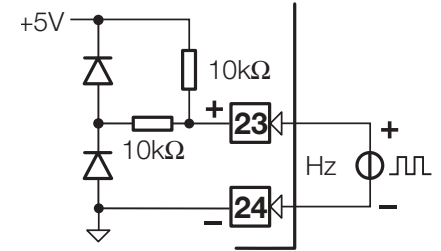

3.3.4 AUXILIARY INPUT



A - From Remote Setpoint

Current 0/4... 20mA;
Input resistance = 30Ω.

Voltage 1... 5V, 0... 5V, 0... 10V;
Input resistance = 300kΩ.

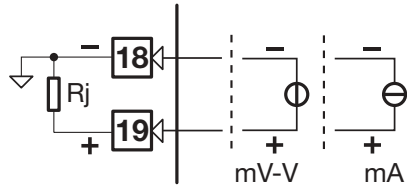

Not available with frequency input.

B- From Potentiometer

or the measure of the position of the motor or the valve:

from 100Ω to 10kΩ max.

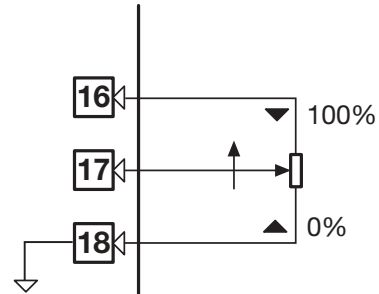
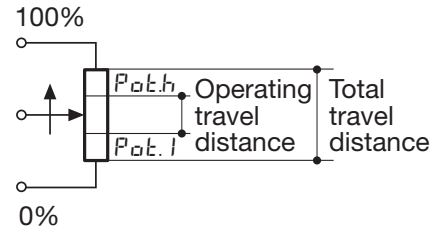

3.3.5 DIGITAL INPUT



- The input is active when the logic state is ON, corresponding to the contact closed.
- The input is inactive when the logic state is OFF, corresponding to the contact open.

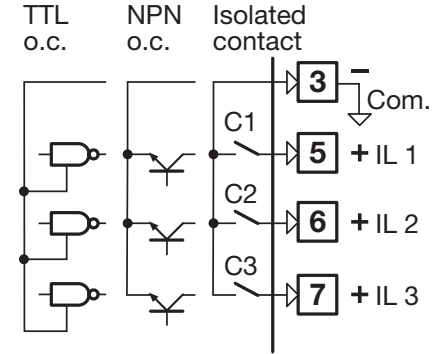

3.3.6 OP1 - OP2 - OP3 - OP4 - OP5 - OP6 OUTPUTS (OPTION)

The functionality associated to each of the OP1, OP2, OP4, OP5 and OP6 output is defined during the configuration of the instrument.

The suggested combinations are:

		Control outputs		Alarms				Retransmission	
		Main (Heat)	Secondary (Cool)	AL1	AL2	AL3	AL4	PV / SP	
A	Single action	OP1			OP2	OP3	OP4	OP5	OP6
B		OP5		OP1	OP2	OP3	OP4		OP6
D	Double action	OP1	OP2			OP3	OP4	OP5	OP6
E		OP1	OP5		OP2	OP3	OP4		OP6
F		OP5	OP2	OP1		OP3	OP4		OP6
G		OP5	OP6		OP2	OP3	OP4		
L	Valve drive	OP1 ▲	OP2 ▼			OP3	OP4	OP5	OP6

where:

OP1 - OP2	Relay or Triac output
OP3 - OP4	Relay outputs
OP5 - OP6	Analogue/ digital control or retransmission outputs

3.3.6-A SINGLE ACTION RELAY (TRIAC) CONTROL OUTPUT 

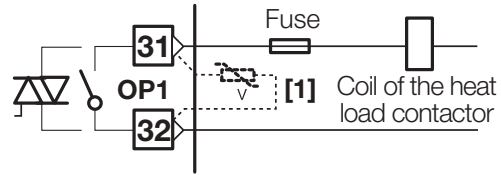

3.3.6-C DOUBLE ACTION RELAY (TRIAC)/RELAY (TRIAC) CONTROL OUTPUT 



3.3.6-B1 SINGLE ACTION SSR DRIVE CONTROL OUTPUT 

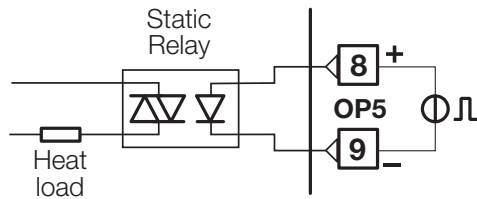

3.3.6-D1 DOUBLE ACTION RELAY (TRIAC)/SSR DRIVE CONTROL OUTPUT 

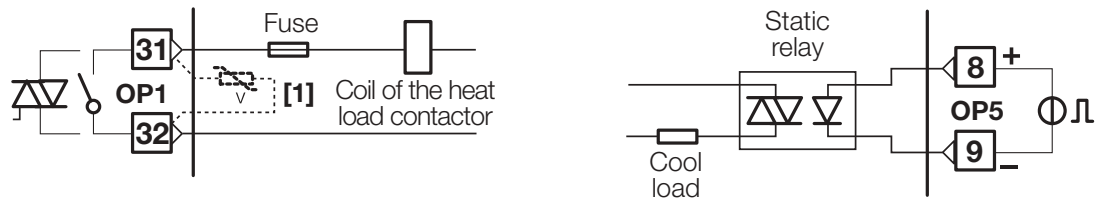

3.3.6-B2 SINGLE ACTION ANALOGUE OUTPUT 

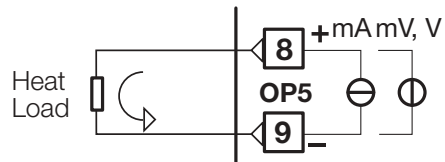

3.3.6-D2 DOUBLE ACTION RELAY (TRIAC)/ANALOGUE CONTROL OUTPUT 

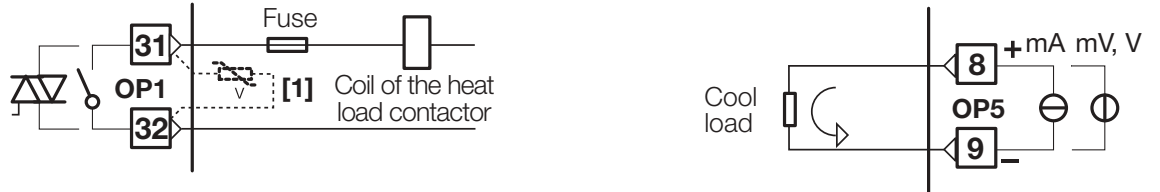

3.3.6-E1 DOUBLE ACTION

DIGITAL/RELAY (TRIAC) CONTROL OUTPUT

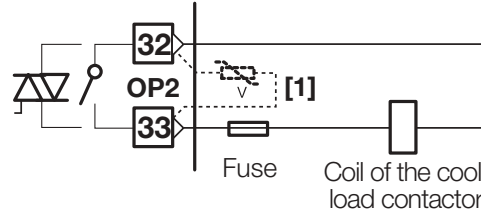
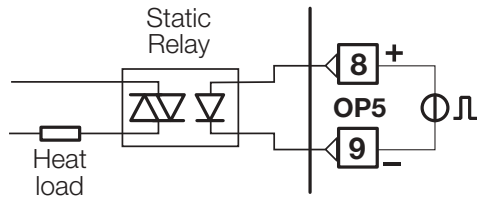

3.3.6-E2 DOUBLE ACTION

ANALOGUE/RELAY (TRIAC) CONTROL OUTPUT

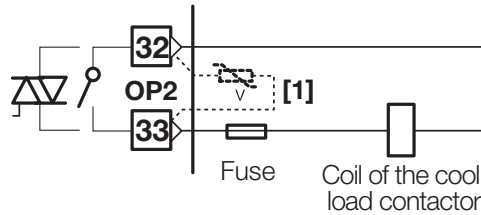
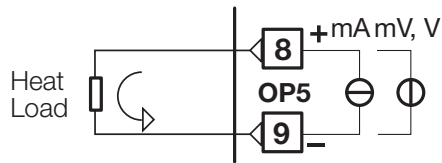

3.3.6-F1 DOUBLE ACTION

DIGITAL/DIGITAL CONTROL OUTPUT

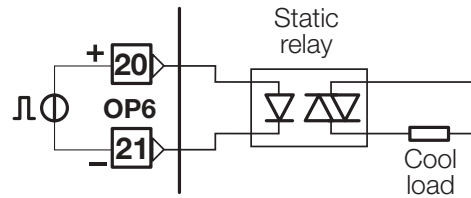
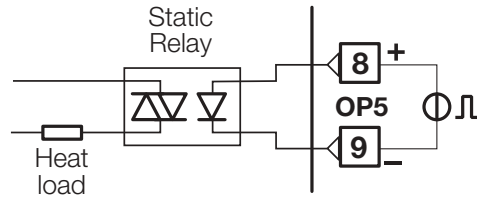

Notes for pages 17 - 18 - 19

OP1 - OP2 Relay output

- SPST Relay N.O., 2A/250 Vac (4A/120Vac) for resistive load,
- Fuse 2AT at 250Vac, 4AT at 110Vac.

OP1 - OP2 Triac output

- N.O. contact for resistive load up to 1A/250 Vac max.
- Fuse 1AT

Isolated digital outputs OP5-OP6

- 0...24Vdc, $\pm 20\%$, 30 mA max.

Isolated analogue outputs OP5-OP6

- 0/4... 20mA, 750 Ω /15V max.;
- 0/1... 5V, 0... 10V, 500 Ω /20mA max.

[1] Varistor for inductive load 24Vac only.

**3.3.6-F2 DOUBLE ACTION
DIGITAL/ANALOGUE CONTROL OUTPUT**

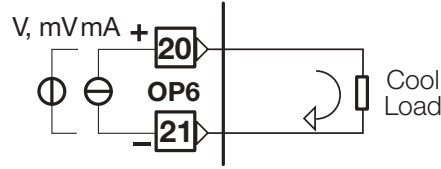
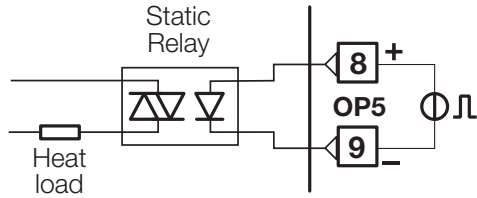

**3.3.6-F3 DOUBLE ACTION
ANALOGUE/DIGITAL CONTROL OUTPUT**

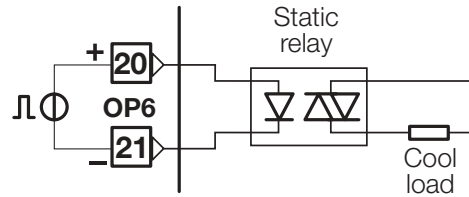
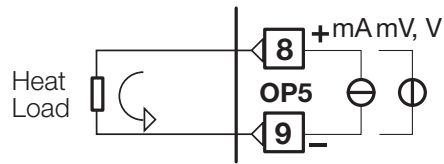

**3.3.6-F4 DOUBLE ACTION
ANALOGUE/ANALOGUE CONTROL OUTPUT**

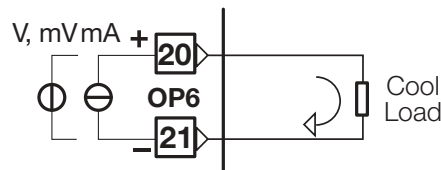
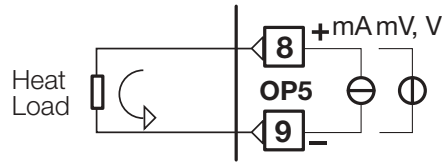

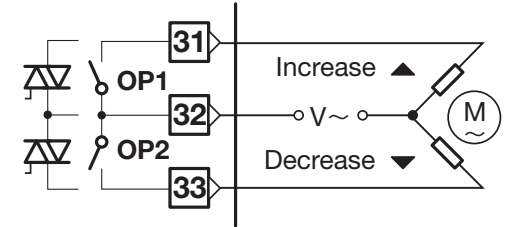

**3.3.6-G MOTOR POSITIONER OUTPUT
RELAY (TRIAC)/RELAY (TRIAC)**

Valve drive PID **without** potentiometer 3 pole output with N.O. contacts (raise, lower, stop).

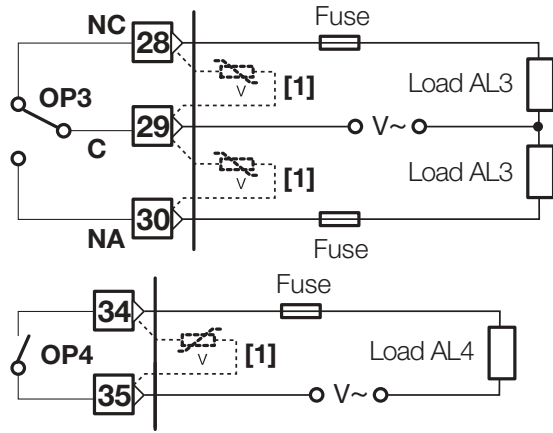

3.3.7 OP1-2-3-4 ALARM OUTPUTS



 The relay/triac output OP1, OP2, can be used as alarm outputs only if they are not used as control outputs.

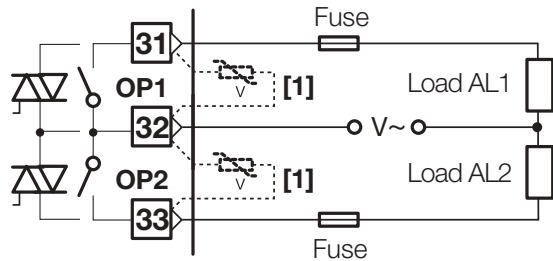

3.3.8 OP5 AND OP6 (OPTION) ANALOGUE CONTROL OUTPUTS

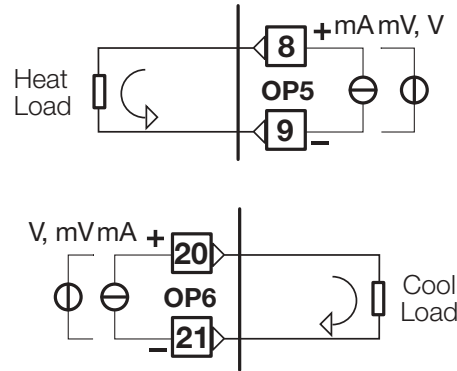

OP5 and OP6 outputs can be configured for control action or PV/SP retransmission:

- Galvanic isolation 500Vac/1 min;
- 0/4... 20mA, 750Ω/15Vdc max.;
- 0/1... 5V, 0... 10V, 500Ω/20mA max..

Notes:

[1] **Varistor for inductive load 24Vac only**

[2]  Please, read the user manual: "gammadue® and delatadue® controller series serial communication and configuration software".

3.3.9 SERIAL COMMUNICATIONS (OPTION) [2]

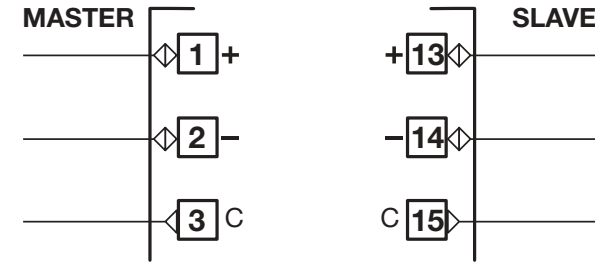

- Galvanic isolation: 500Vac/1 min;
Compliance to the EIA RS485 standard for Modbus/Jbus;
- Termination setting dip switches.

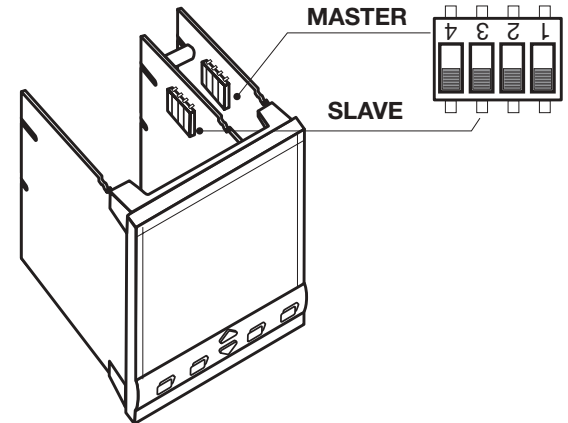



3.3.10 PROFIBUS DP (OPTION)

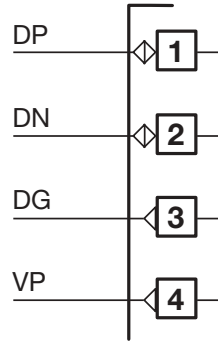

- Galvanic isolation 500 Vac/1 min;
- Compliance to the EIA RS485 standard for PROFIBUS DP;
- Connecting cable: twisted pair cable as per PROFIBUS specifications (e.g. Belden B3079A);
- Max. length: 100 m at 12 Mb/s.

Termination resistors 220Ω and 390Ω ($1/4$ W, $\pm 5\%$) for external mounting on the initial and ending PROFIBUS stations only.

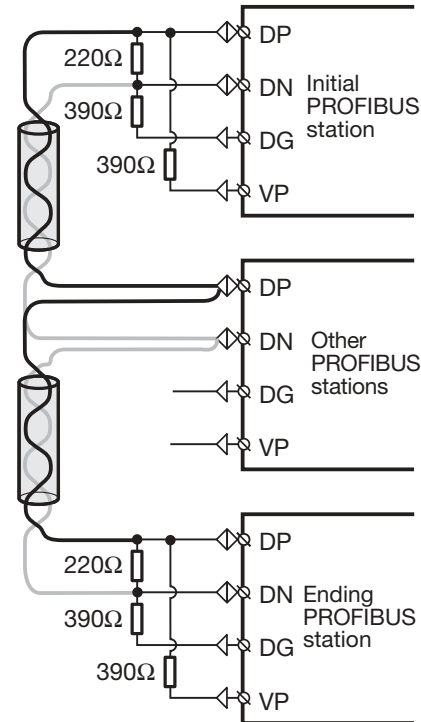

To make the connections easier, a D-Sub type (9 poles) connector: model **AP-ADP-PRESA-DSUB/9P** Must be used with a 9PIN male ERNI type part no. 103648 or similar connector.

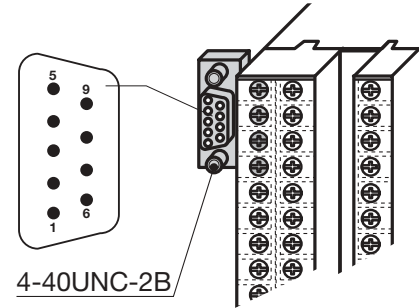

X5	D-SUB 9 poles	Signal	Description according to PROFIBUS specifications
1	3	RxD/TxD-P (DP)	Receive data/transmission data plus
2	8	RxD/TxD-N (DN)	Receive data/transmission data negative
3	5	DGND (DG)	Data transmission potential (ground to 5V)
4	6	VP (VP)	Supply voltage of the terminating resistance-P, (P5V)

Detailed information concerning wiring and cables can be found on the PROFIBUS Product Guide or on Internet at: <http://www.profibus.com/online/list>

4 OPERATION

4.1.1 KEY FUNCTIONS AND DISPLAYS IN OPERATOR MODE

Status LEDs (green)

- SCI** Communications running
- AT** Tuning running
- RUN** Timer/Program running
- HLD** Program Waiting
- REM** Remote Setpoint active
- S1** First stored Setpoint active
- S2** Second stored Setpoint active
- S3** Third stored Setpoint active

Alarm status LEDs (red)

- 1** AL1 ON
- 2** AL2 ON
- 3** AL3 ON
- 4** AL4 ON

Digital input status LEDs (yellow)

- I1** - IL1 active
- I2** - IL2 active
- I3** - IL3 active

Run/stop Timer or a program

Menu access

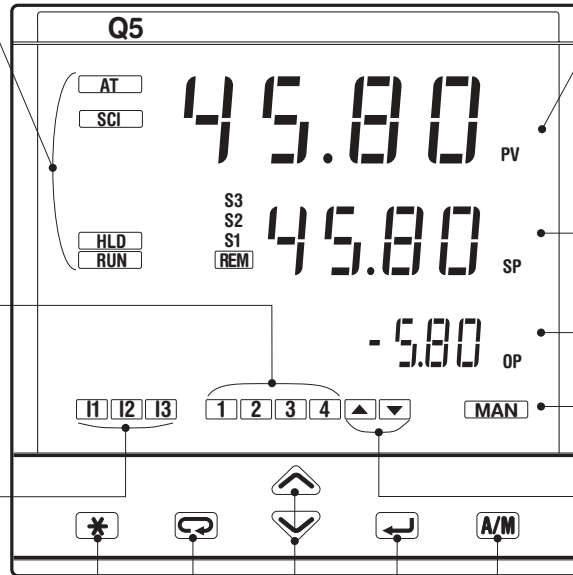

PV control input in engineering units



SP operating Setpoint (Local/Remote or Stored)

% Control output or Program status (see page 64)

Status LEDs (green)

MAN Manual operating mode

Control output LEDs (red)

▲ OP1/OP4 ON - **▼** OP2/OP4 OFF

Auto/Man



Entry key for selection and value setting confirmation

Setpoint setting

4.1.2 KEYS FUNCTIONS AND DISPLAY IN PROGRAMMING MODE



The parameter setting procedure has a timeout. If no keys are pressed for, at least, 30 seconds, the controller switches back, automatically, to the operator mode.

After having selected the parameter or the code, press  and  to display or modify the value.

The value is entered when the next parameter is selected, by pressing the  key.

Pressing the back key  or after 30 seconds from the last modification, the value doesn't change.

From every parameter, pressing the  key, the controller switches to the operator mode.

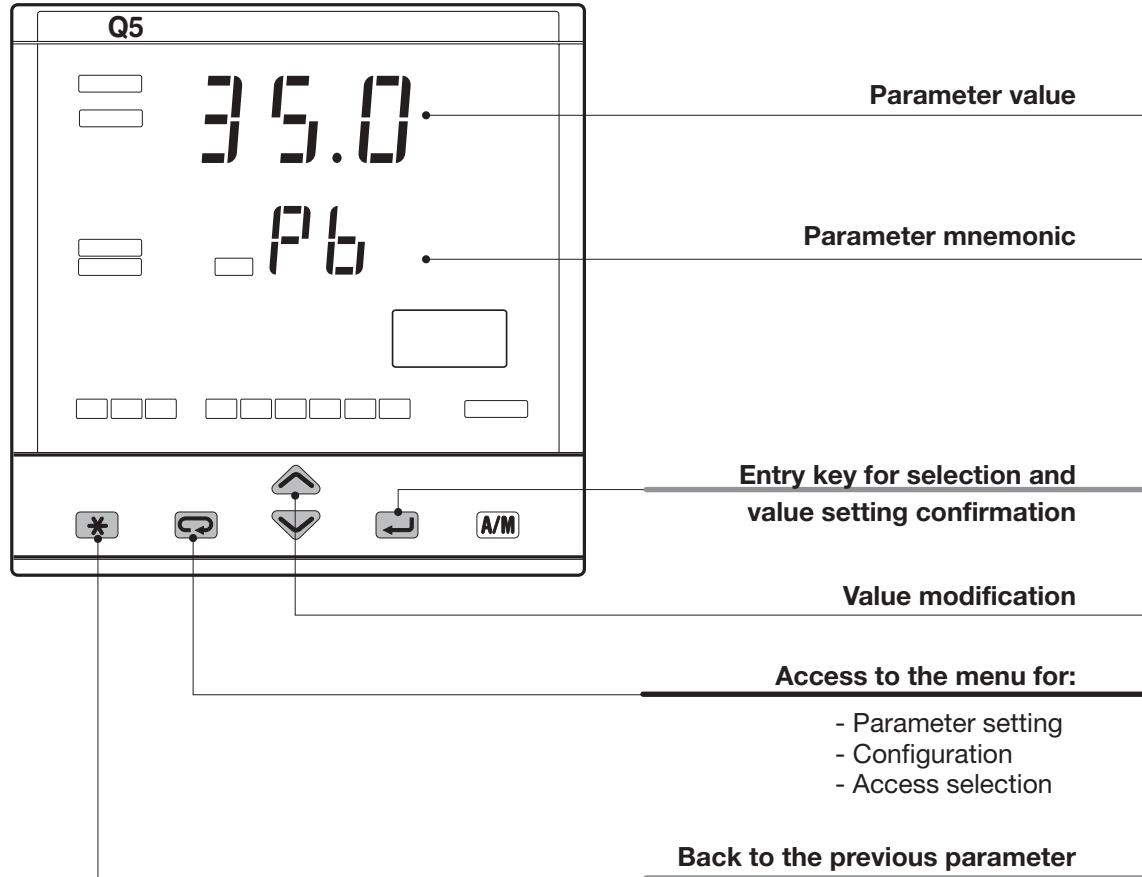

4.2 PARAMETER SETTING

4.2.1 NUMERIC ENTRY

(i.e. the modification of the Setpoint value from 275.0 to 240.0)

Press or momentarily to change the value of 1 unit every push.

Continued pressing of or changes the value, at rate that doubles every second. Releasing the button the rate of change decreases.

In any case the change of the value stops when it has reached the max/min limit set for the parameter.

In case of Setpoint modification: press or once to display the local Setpoint instead of working Setpoint.

To evidence this change the display flashes once. Then the Setpoint can be modified

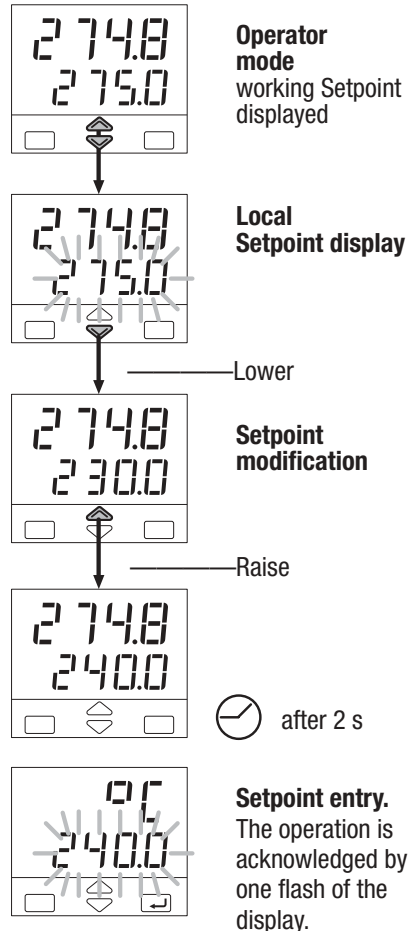

4.2.2 MNEMONIC CODES SETTING

(e.g. configuration see page 26)

Press the or to display the next or previous mnemonic for the selected parameter.

Continued pressing of or will display further mnemonics at a rate of one mnemonic every 0.5 s. The mnemonic displayed at the time the next parameter is selected, is the one stored in the parameter.

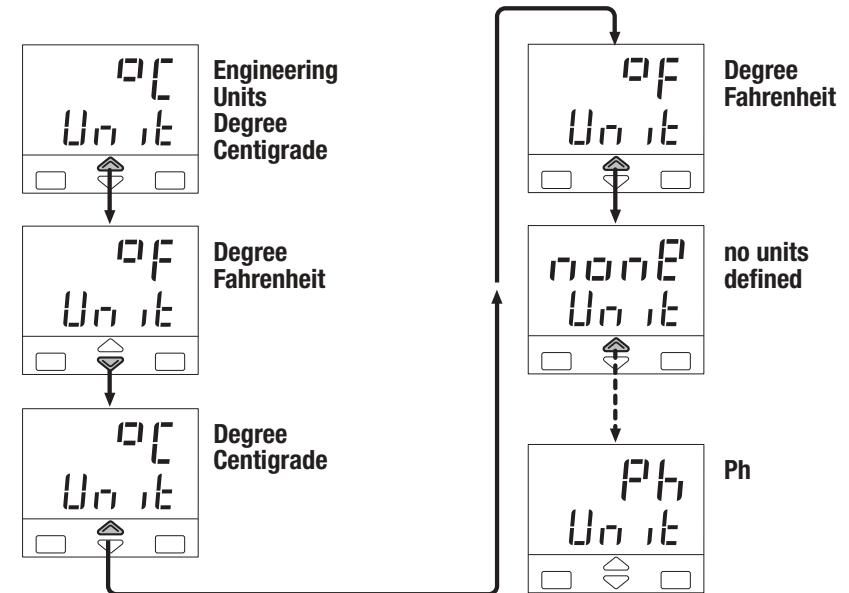

4.3 CONFIGURATION PROCEDURE

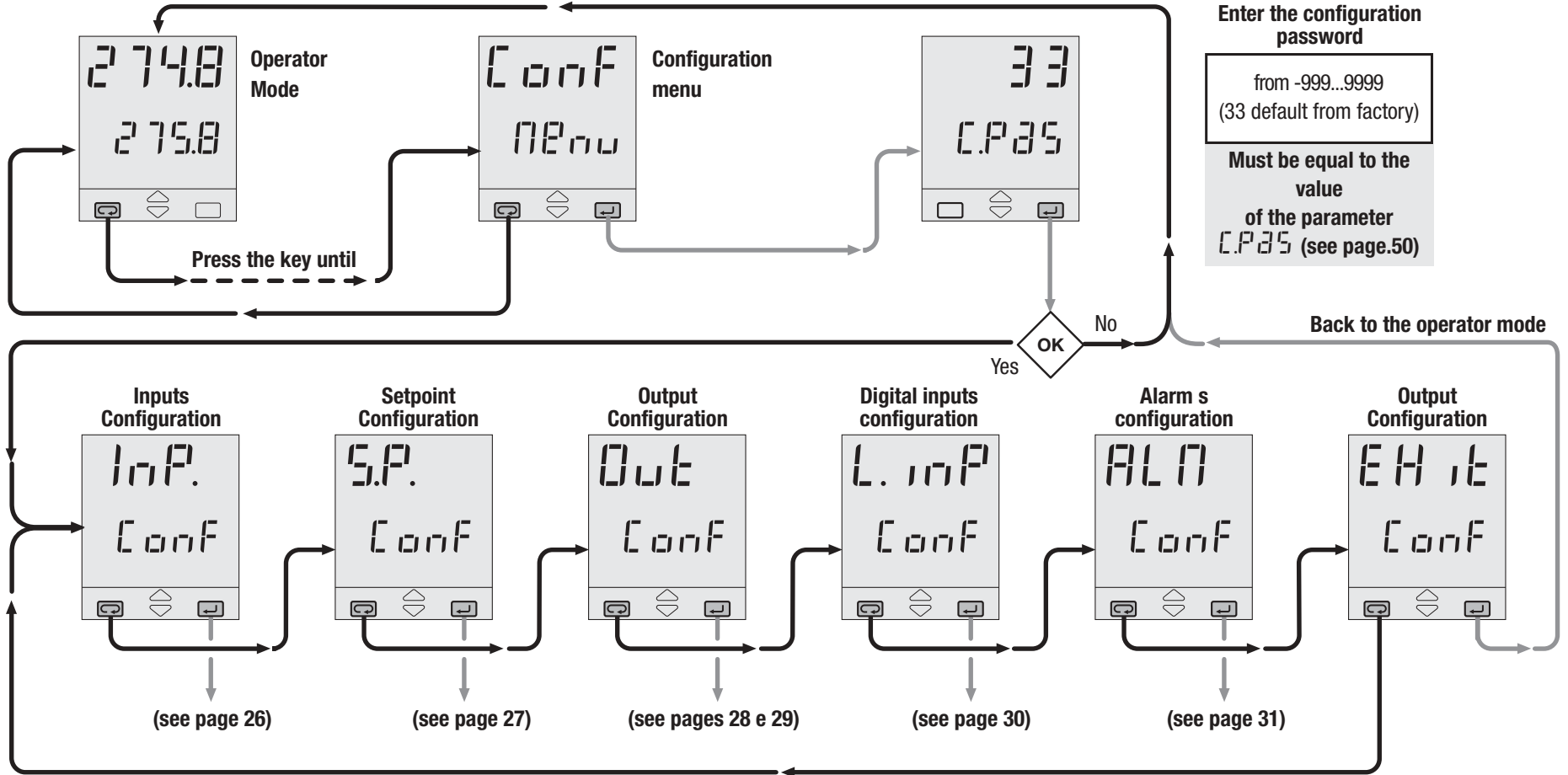

4.3.1 INPUTS CONFIGURATION

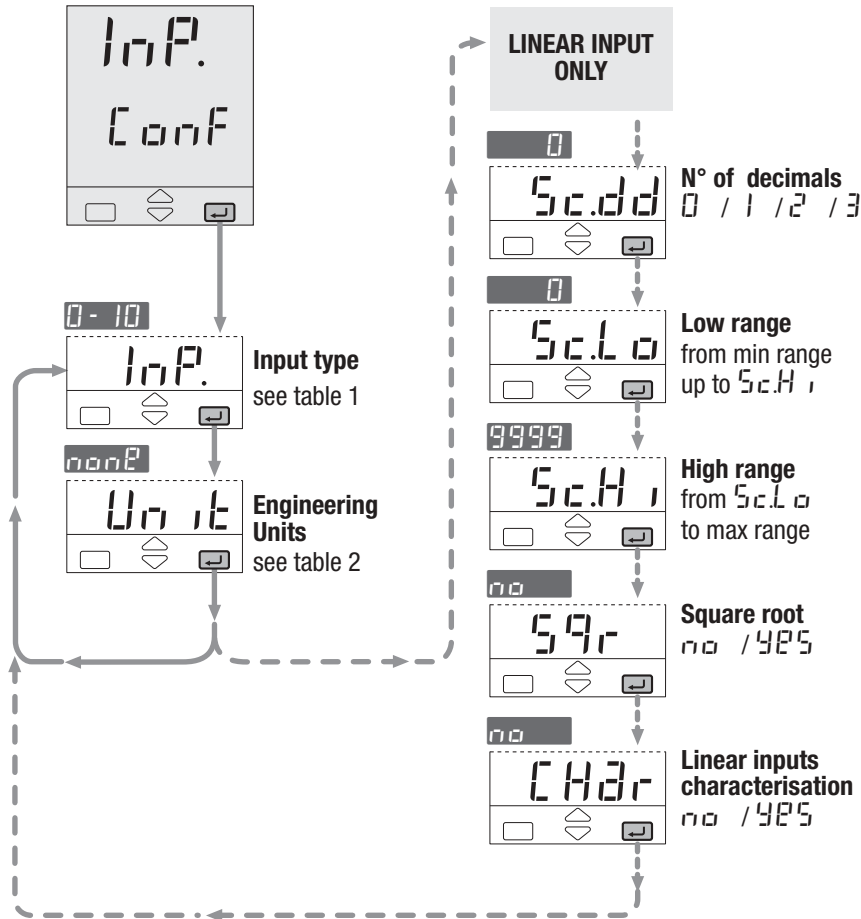

Tab. 1 Input type			
Value	Description	InP.	
t.c. J	0...600°C	32...1112°F	
t.c. K	0...1200°C	32...2192°F	
t.c. L	0...600°C	32...1112°F	
t.c. S	0...1600°C	32...2912°F	
t.c. r	0...1600°C	32...2912°F	
t.c. t	-200...400°C	-328...752°F	
t.c. b	0...1800°C	32...3272°F	
t.c. n	0...1200°C [1]	32...2192°F	
t.c.n ,	0...1100°C [2]	32...2012°F	
t.c.U3	0...2000°C	32...3632°F	
t.c.U5	0...2000°C	32...3632°F	
t.c. E	0...600°C	32...1112°F	
c.u5t	Custom range	on request	
r.t.d.1	-200...600°C	-328...1112°F	
r.t.d.2	-99.9...300.0°C	-99.9...572.0°F	
d.P.L.t	-50.0...50.0°C	-58.0...122.0°F	
n.50	0...50 mV	Engineering units	
n.300	0...300 mV		
0-5	0...5 Volt		
1-5	1...5 Volt		
0-10	0...10 Volt		
0-20	0...20 mA		
4-20	4...20 mA		
Fr.9.L	0...2.000 Hz		Frequency (option)
Fr.9.H	0...20.000 Hz		

Tab. 2 Engineering units		
Value	Description	Unit
none	None	
°C	Degree centigrade	
°F	Degree Fahrenheit	
mA	mA	
mV	mV	
V	Volt	
bar	bar	
PSI	PSI	
Rh	Rh	
Ph	Ph	
Hz	Hertz	

Notes:

- [1] NiChroSil-NiSil thermocouple
[2] Ni-Mo thermocouple.

4.3.2 SETPOINT CONFIGURATION

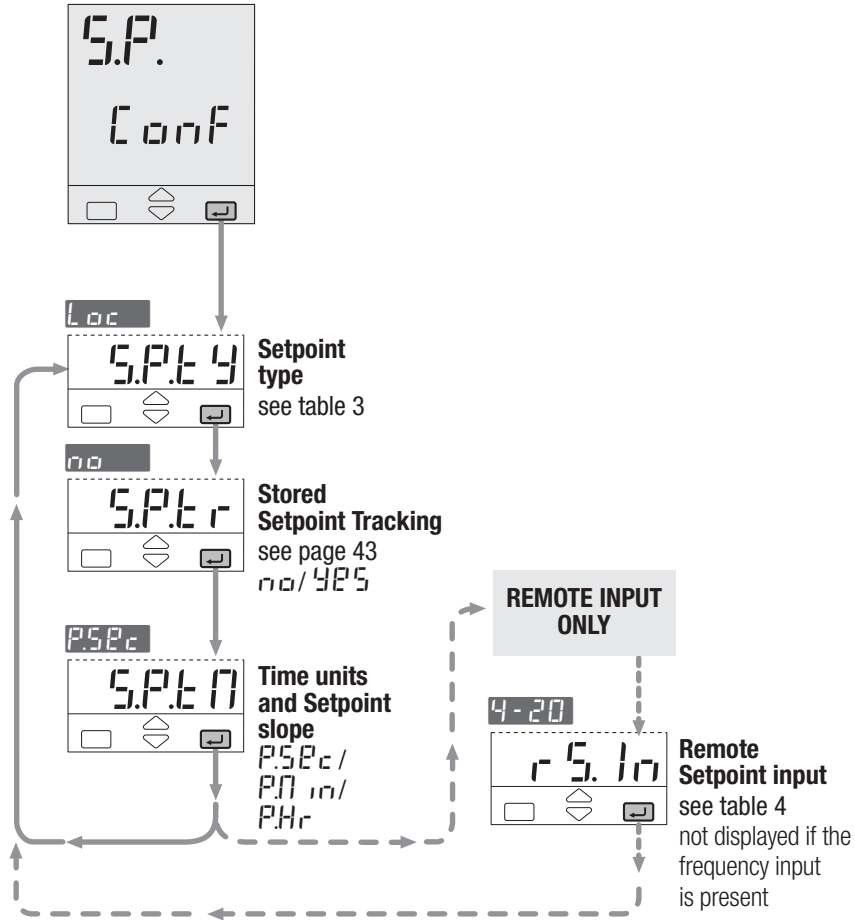

Tab. 3 Setpoint type

Value	Description	S.P.E.Y
Loc	Local only	
rPn	Remote only	
L-r	Local/remote only	
Loc.t	Local - trim	
rPn.t	Remote - trim	
PrOg	Programmed (option)	

Tab. 4 Rem. Setpoint

Value	Description	rS.in
0-5	0...5 Volt	
1-5	1...5 Volt	
0-10	0...10 Volt	
0-20	0...20 mA	
4-20	4...20 mA	

4.3.3 OUTPUT CONFIGURATION

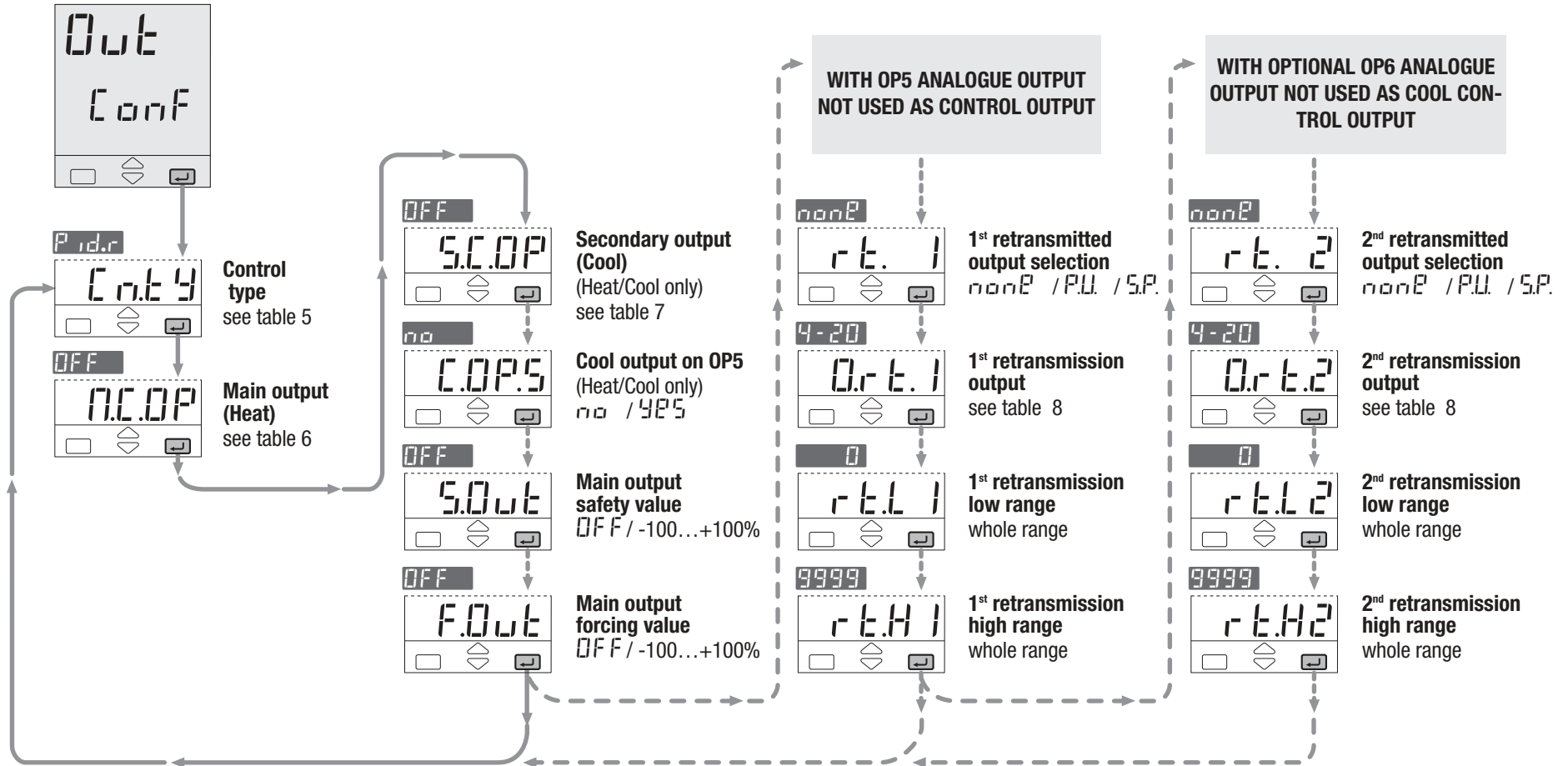

Tab. 5 Control mode		
Value	Description	Control
OFF	Reverse action	On - Off
DIR	Direct action	
DIR	Direct action	P.I.D.
REV	Reverse action	
DIR	Direct action	Modul. valves
REV	Reverse action	
HEAT	Linear	Heat/ Cool
COOL	Oil charac.	
HEAT	Water charac.	

Tab. 6 Main Output (Heat)		
Value	Description	Signal
OFF	Not used	
OP 1	Relay / Triac	Digital signal
LOG	Digital	
0-5	0...5 Volt	DC signal
1-5	1...5 Volt	
0-10	0...10 Volt	
0-20	0...20 mA	
4-20	4...20 mA	

Tab. 7 Secondary output (Cool)		
Value	Description	Signal
OFF	Not used	
OP 2	Relay / Triac	Digital signal
LOG	Digital	
0-5	0...5 Volt	DC signal
1-5	1...5 Volt	
0-10	0...10 Volt	
0-20	0...20 mA	
4-20	4...20 mA	

Tab. 8 Retransmission outputs		
Value	Description	Signal
		Ret. 1
0-5	0...5 Volt	Ret. 2
1-5	1...5 Volt	
0-10	0...10 Volt	
0-20	0...20 mA	
4-20	4...20 mA	

RETRANSMISSION

When OP5 and OP6 outputs are not configured as control output, they can retransmit the PV or SP linearised value.

Retransmitted signal
non P.U. / SP

Output range
0-5 / 1-5 / 0-10
0-20 / 4-20

The following parameters define the low and high range.

Retransmission low range

Retransmission high range

Example:

- T/C S, range 0...1600°C;
- Output range, 4...20 mA;
- Retransmitted signal PV on 800...1200°C range.

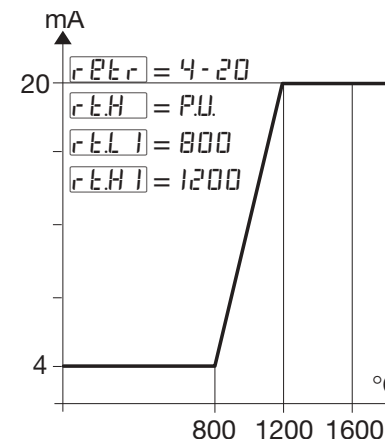

With $rEL1$ greater than $rEH1$ is possible to obtain a reverse scale.

4.3.4 DIGITAL INPUTS CONFIGURATION

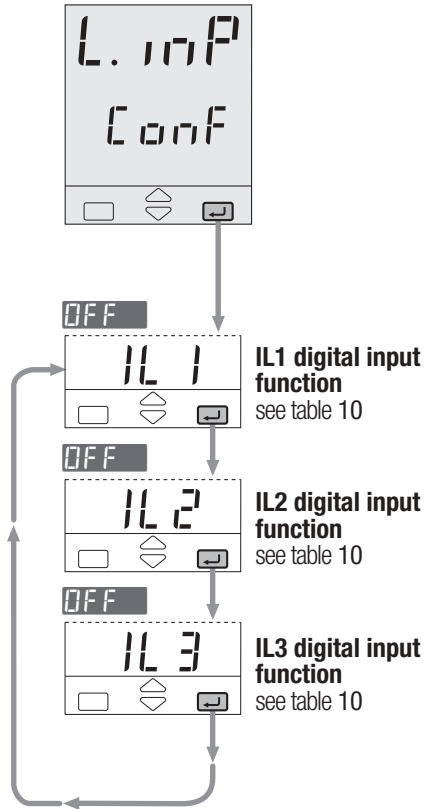

Tab. 10 Digital Inputs functions

Value	Description	
OFF	Not used	IL 1
L-r	Local/Remote	IL 2
Auto/Man		IL 3
S.P. 1	1 st stored Setpoint	
S.P. 2	2 nd stored Setpoint	
S.P. 3	3 rd stored Setpoint	
EEP.1	Keyboard lock	
SLD.1	S.P. slope disable	
HPU	Measure hold	
FOUt	Output forcing mode	
Pr 9.1	1 st program	up to 3
Pr 9.2	2 nd program	
Pr 9.3	3 rd program	
Pr 9.4	4 th program	
r.-H.	Program Run/Stop	
rSt	Program reset	
BLck	Reset blocking	

4.3.5 ALARMS CONFIGURATION

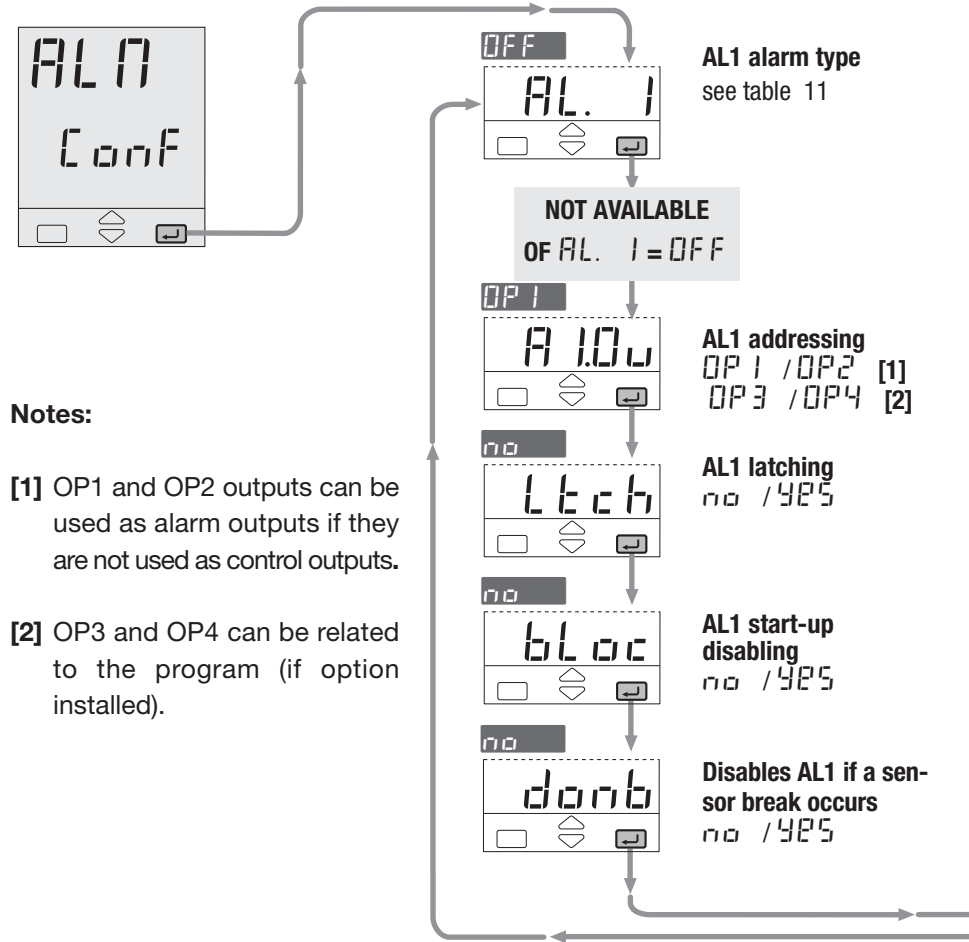

Notes:

[1] OP1 and OP2 outputs can be used as alarm outputs if they are not used as control outputs.

[2] OP3 and OP4 can be related to the program (if option installed).

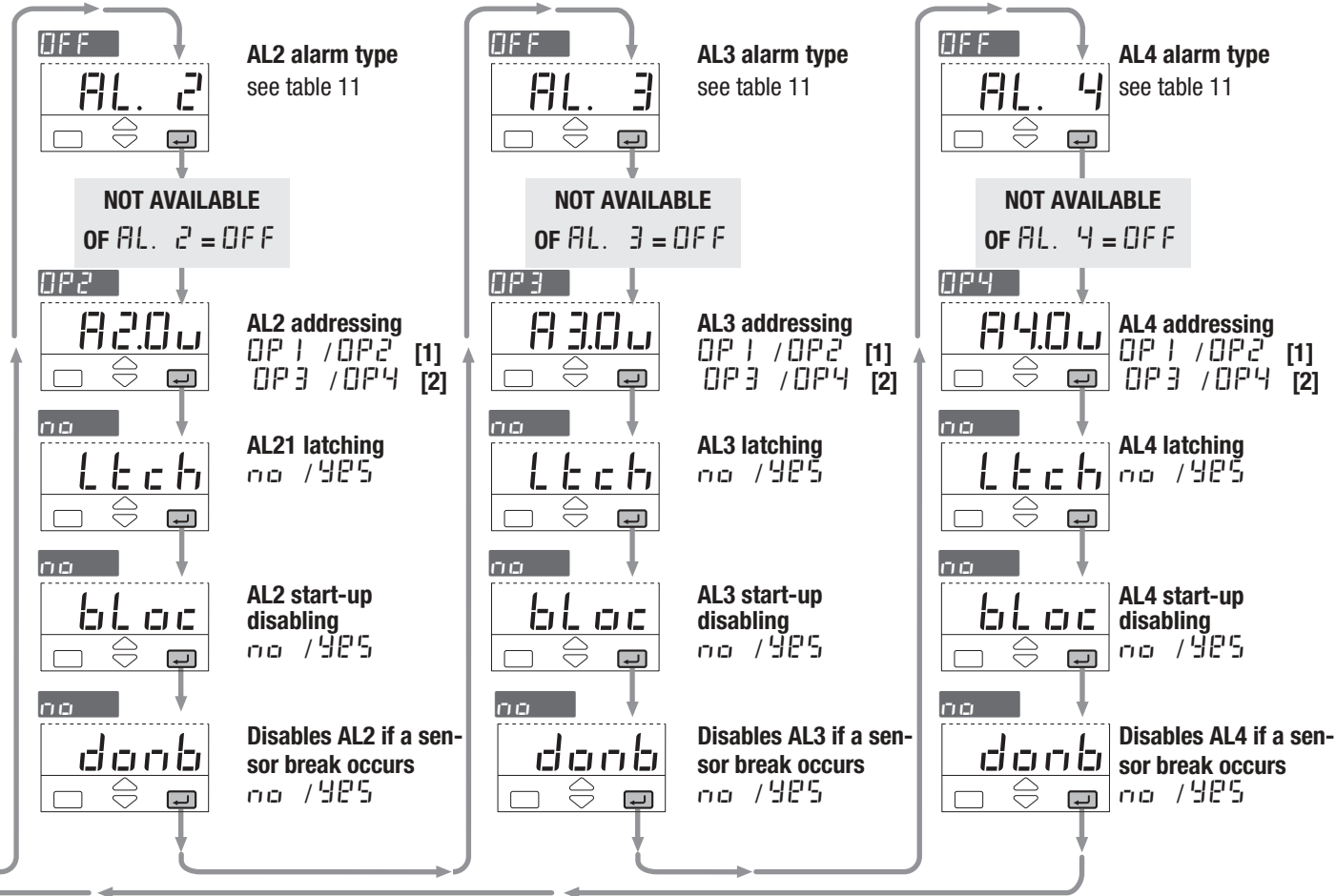

Tab. 11 Alarm type

Value	Description	
AL 1		
AL 2		
AL 3		
AL 4		
OFF	Not used or used by the programme (AL3/AL4)	
F5.H	High active	Absolute
F5.L	Low active	
dPUH	High active	Deviation
dPUL	Low active	
b2nd	Out active	Band
Lb2	Loop break alarm (AL1 only)	

4.3.6 AL1, AL2, AL3, AL4 ALARMS CONFIGURATION

It is possible to configure up to 4 alarms: AL1, AL2, AL3, AL4 (see page 31) selecting, for each of them:

- A** the type and the operating condition of the alarm (table 11 page 31);
- B** the functionality of the alarm acknowledge (latching) `Ltch`
- C** the start-up disabling (blocking) `blac` ;
- D** the physical output of the alarm `OP1` `OP2` `OP3` `OP4` ;

The outputs can be used for alarms if they are not used as control outputs (see par. 3.3.7 page 20).

It is possible to route up to 4 alarm to a single output (OR of the alarms).

Alarm occurrence display

This function can be enabled by the configuration software.

Please, read the user manual: "gamma^{due}® and delta^{due}® controller series serial communication and configuration software".

The type of alarm is presented flashing, on the front panel in alternation with the PV value.

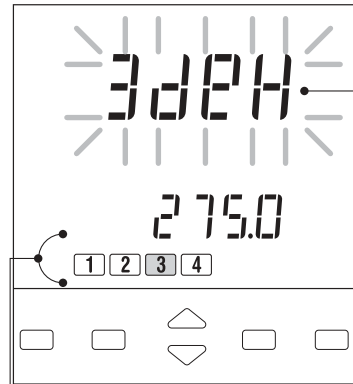

The red led of the activated alarm output is on.

[A] OPERATING CONDITIONS

Absolute alarm

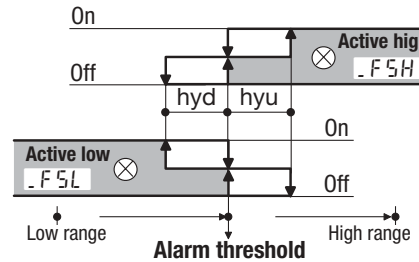

Deviation alarm

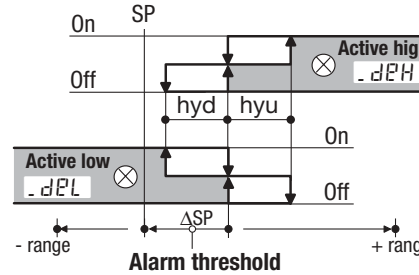

Band alarm

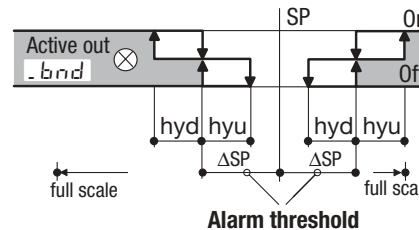

[B] ALARM ACKNOWLEDGE FUNCTION (LATCHING)

The alarm, once occurred, is presented on the display until to the time of acknowledge. The acknowledge operation consists in pressing any key.

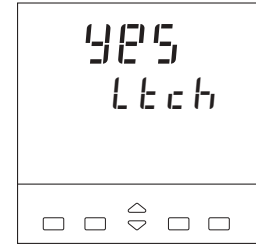

After this operation, the alarm leaves the alarm state only when the alarm condition is no longer present.

**[C] START-UP DISABLING
(BLOCKING)**

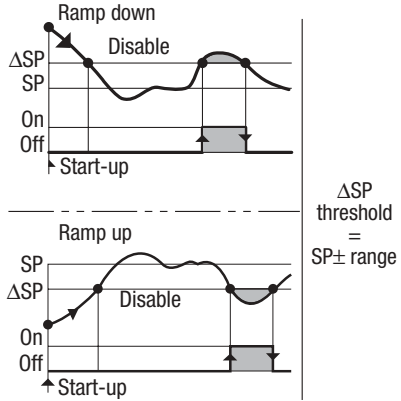
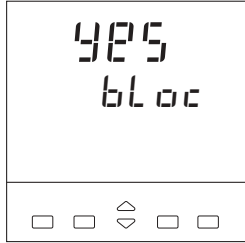

**[D] LOOP BREAK ALARM
(LBA)**

When the controller connection to the sensor is discontinued or other faults are detected in the control loop, the AL1 alarm becomes active, after a predefined time of 1 to 9999 s, from the detection of the failure (see page 37)

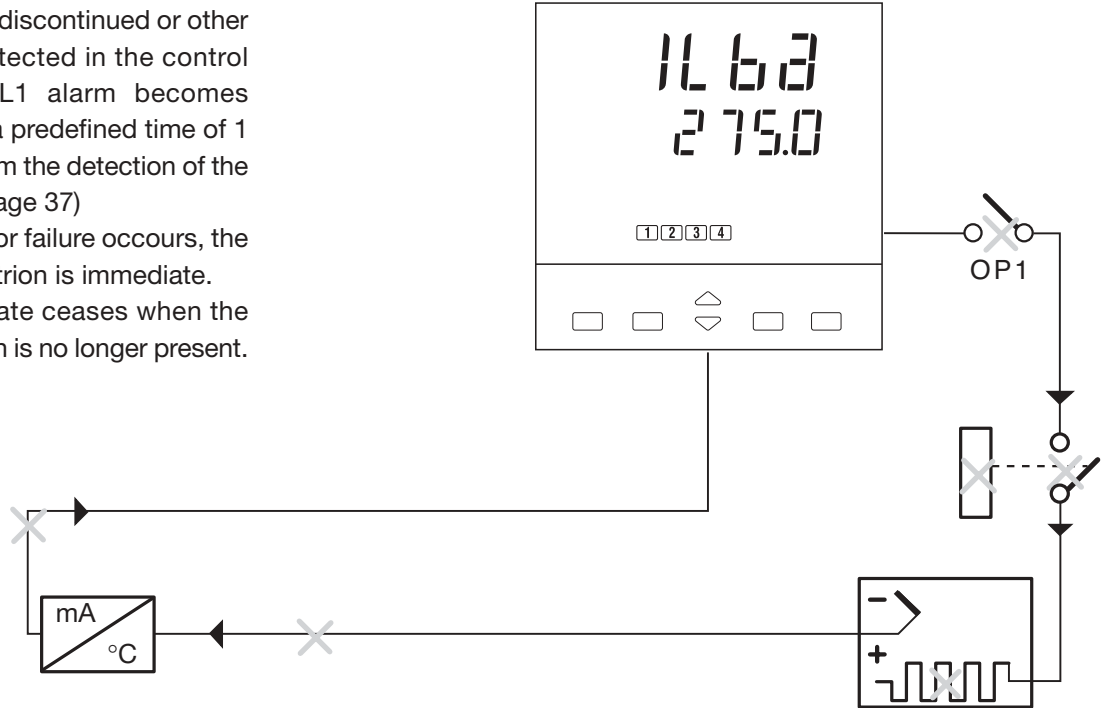

When a sensor failure occurs, the LBA intervention is immediate. The alarm state ceases when the fault condition is no longer present.

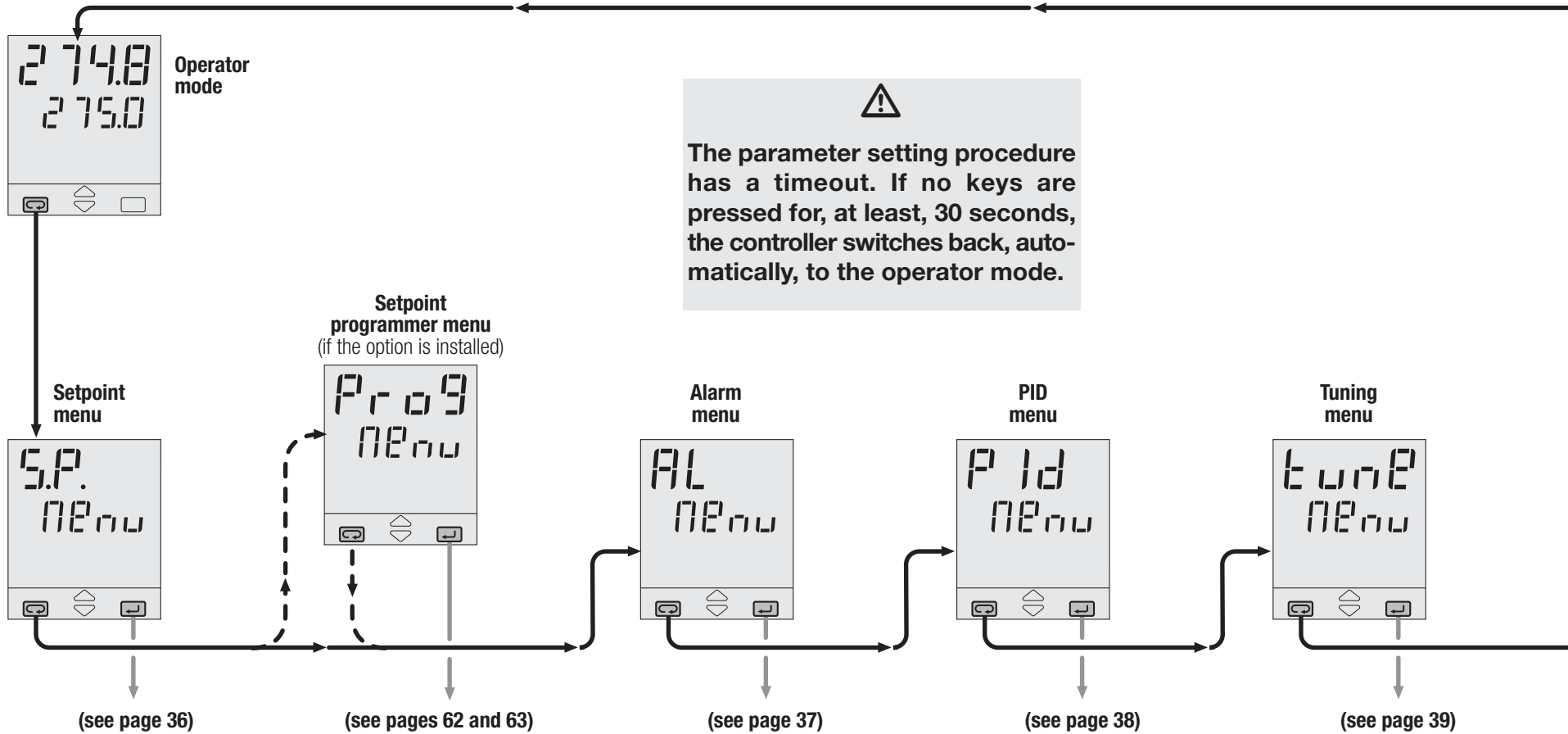

⚠ In case of ON-OFF control, the LBA alarm is not active.

4.4 PARAMETERISATION - MAIN MENU



After having selected the parameter or the code, press  or  to modify the value (see page 24) The value is entered when the next parameter is entered, by pressing the  key.

Pressing  go back to the Operator mode

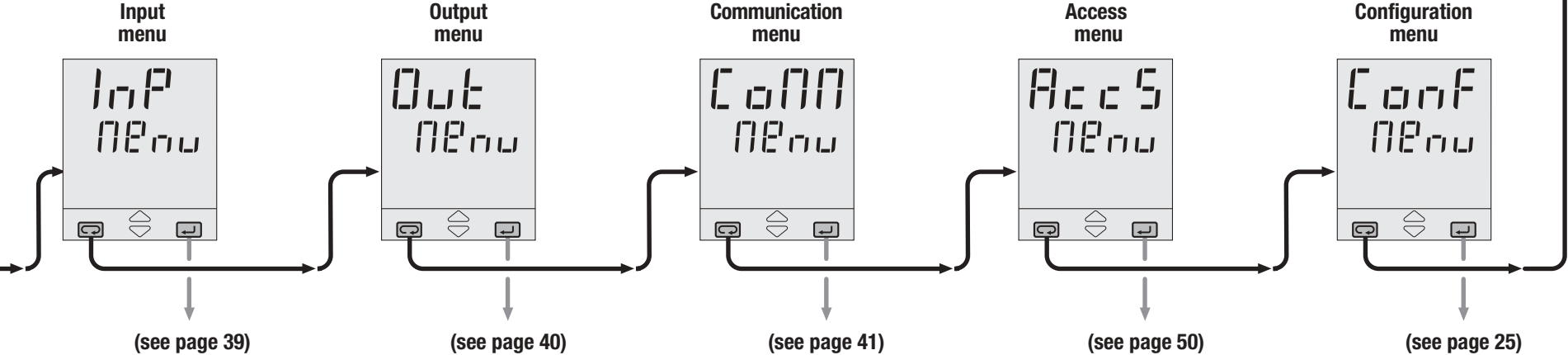

4.4.1 PARAMETERISATION - SETPOINT MENU

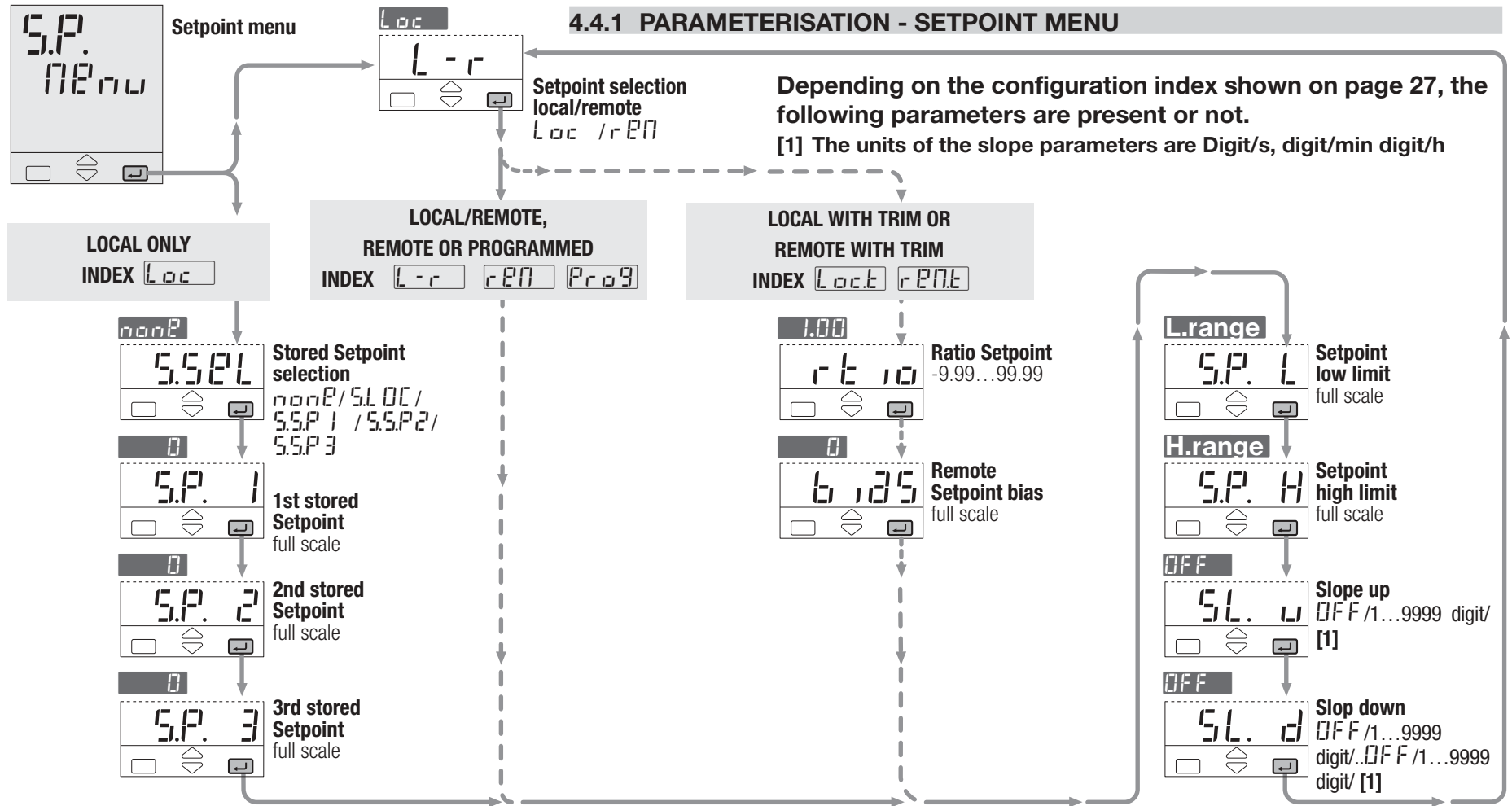

4.4.2 PARAMETERISATION - ALARMS MENU

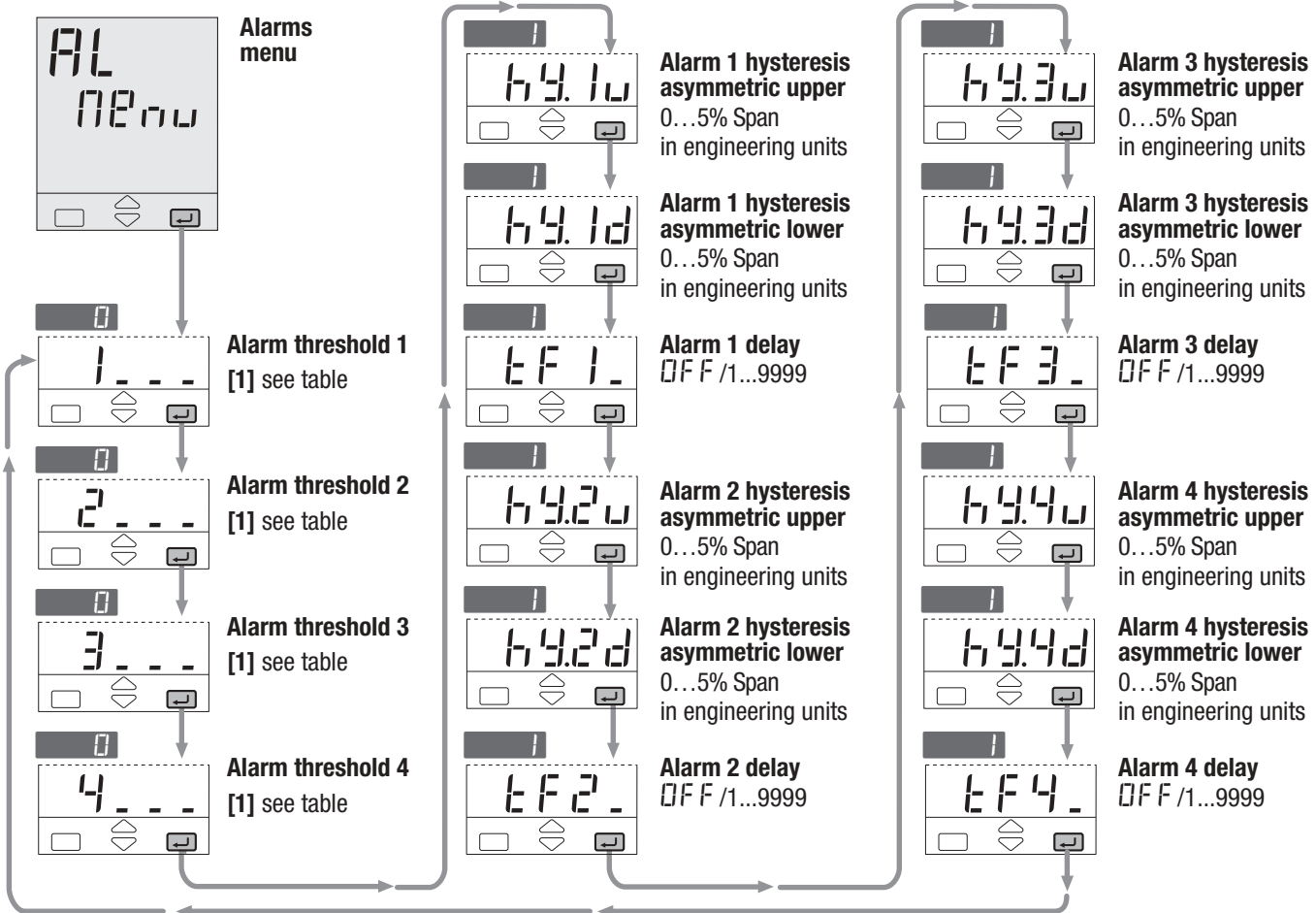

[1] A code, specifying the alarm Number and the alarm type that has been configured (see page 31), is displayed. At this point, the user must enter the threshold value, according to the following table.

Type and value	Mode	N° and Param.
Absolute full scale	Active high	-F5.H
	Active low	-F5.L
Deviation full scale	Active high	-dE.H
	Active low	-dE.L
Band full scale	Active out of band	-brd
L.B.A. 1...9999 s	Active high	-Lb3

4.4.3 PARAMETERISATION - PID MENU (not shown for ON-OFF control action)

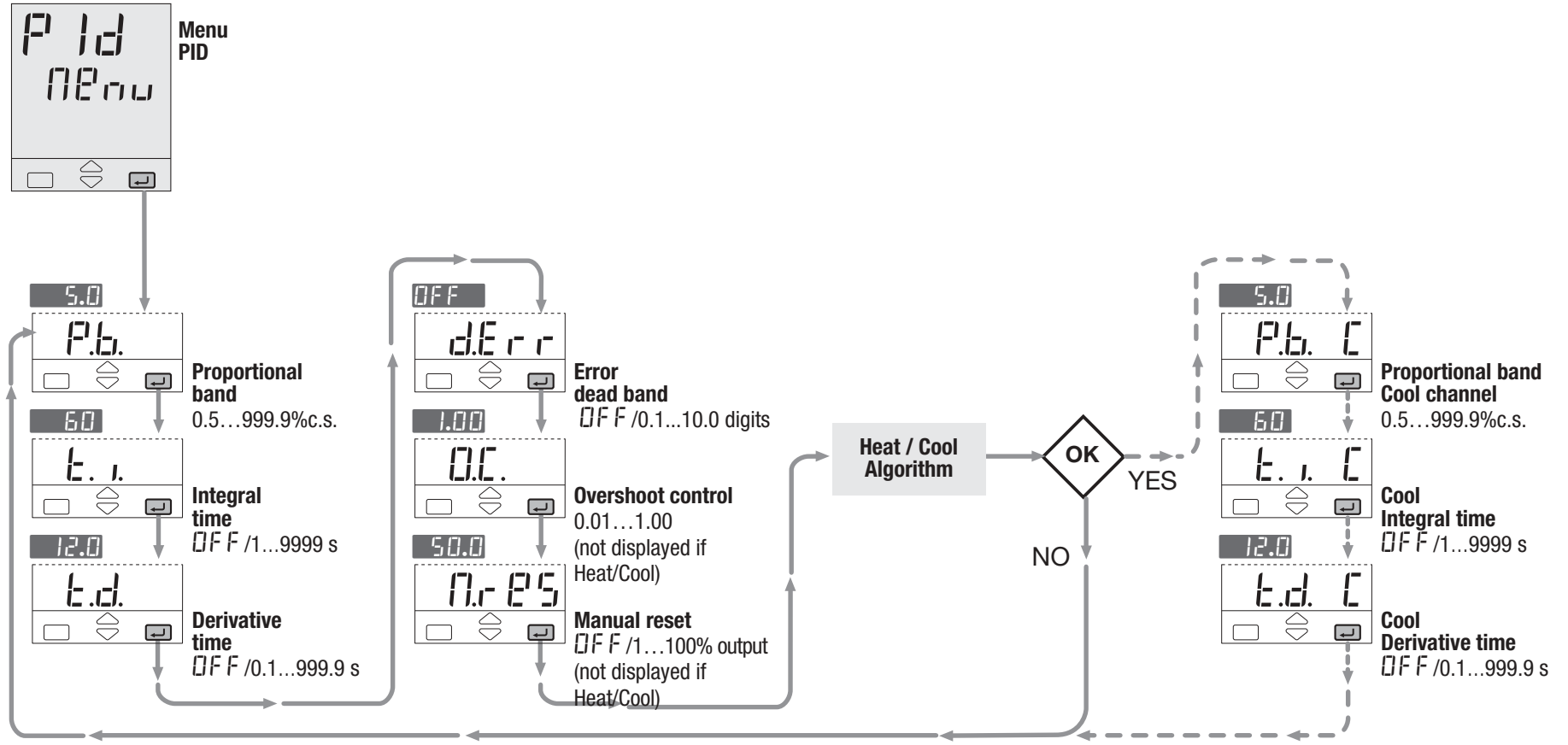

4.4.6 PARAMETERISATION - OUTPUT MENU

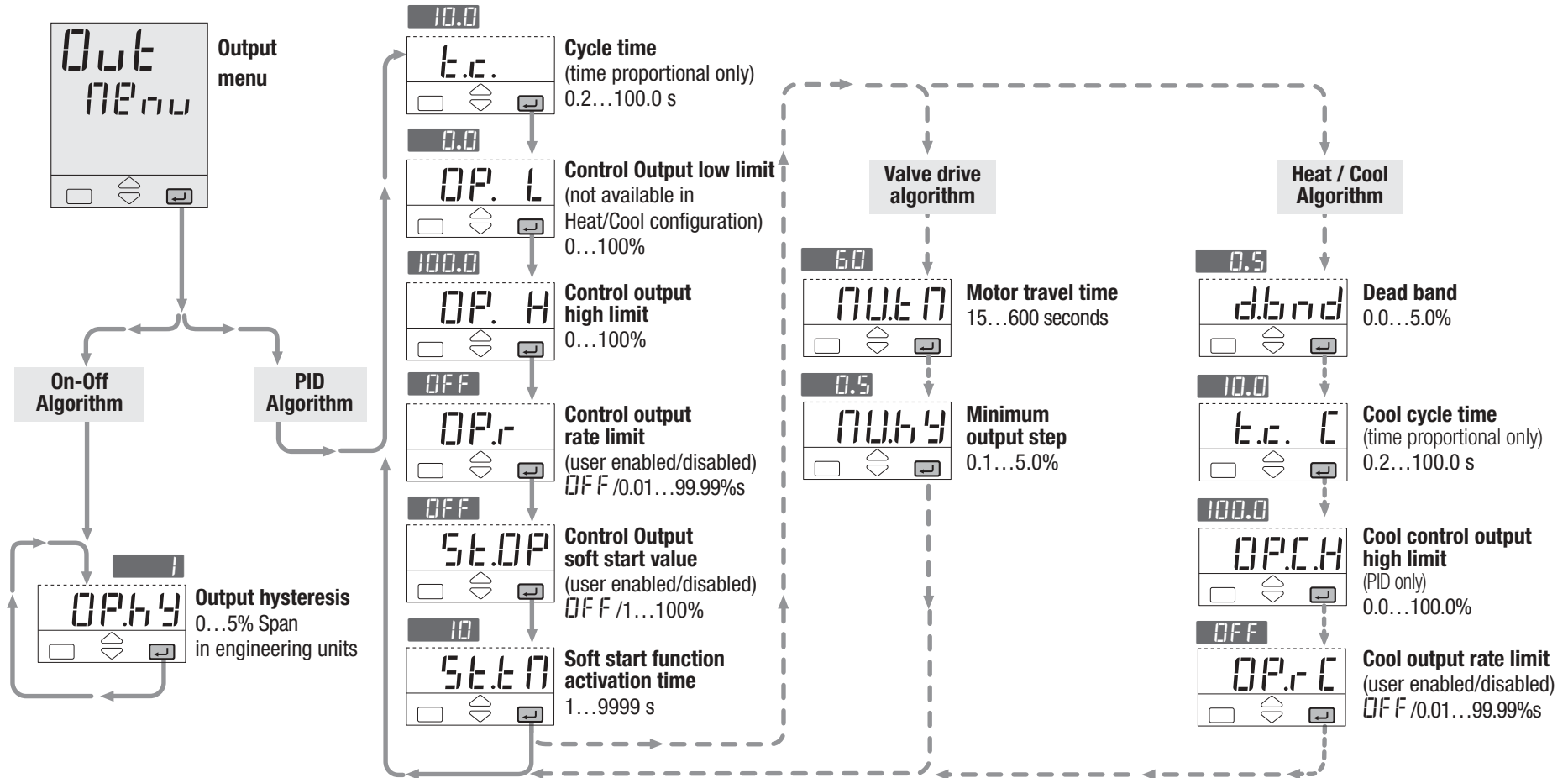

4.4.7 PARAMETERISATION - SERIAL COMMUNICATION MENU

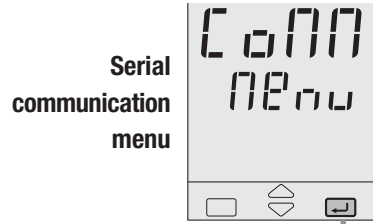

Depending on serial communication chosen (see model code on page 5), there are the following parameters:

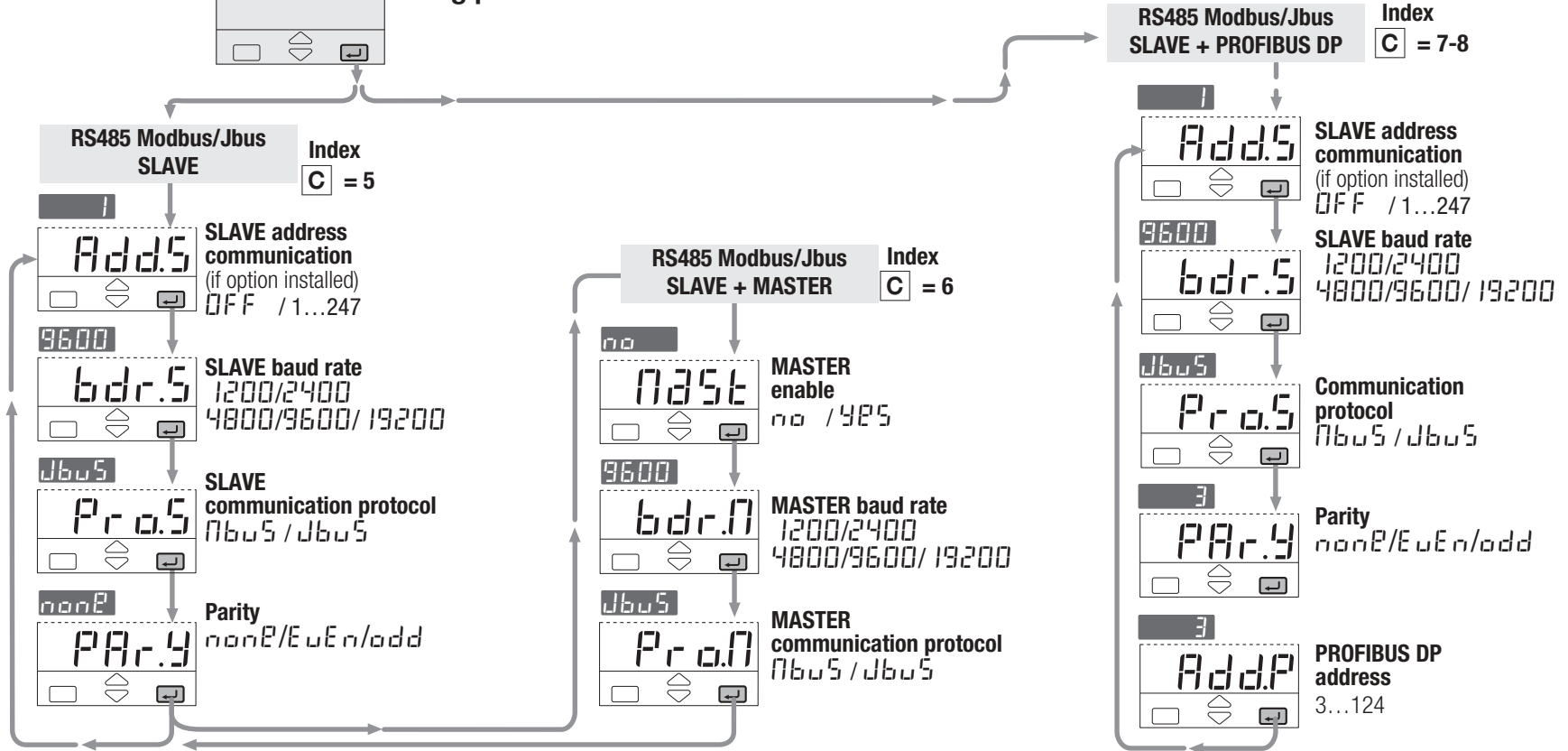

4.5 PARAMETERS

For a simpler use of the controller, its parameters have been organised in menu, according to their functionality area.

S.P. L

**Setpoint
low limit**

S.P. H

**Setpoint
high limit**

High and low limit of the Setpoint SP.

The minimum span (S.P.L - S.P.H) must be greater than 100 digit.

S.L. u

**Setpoint
ramp up**

S.L. d

**Setpoint
ramp down**

This parameter specifies the maximum rate of change of the Setpoint.

Adjustable in digit/s,digit/min, and digit/hour (see page 27)

When the parameter is OFF, this function is disabled and the new Setpoint is reached immediately after being entered.

4.5.1 SETPOINT MENU

Otherwise, the Setpoint value is reached according to the configured rate of change.

The new Setpoint value is called "Target Setpoint". It can be displayed by means the parameter **S.P.** (see procedure at page 53).

When Remote Setpoint is configured, we suggest to disable **S.L. u** and **S.L. d** parameters **OFF**.

S.P. 1

**1st stored
Setpoint**

S.P. 2

**2nd stored
Setpoint**

S.P. 3

**3th stored
Setpoint**

Values of the three Setpoints, that are activated by mean of logic inputs, communication parameters, and keyboard. The Setpoint active is indicated by the **S1**, **S2** or **S3** green led.

See also page 56.

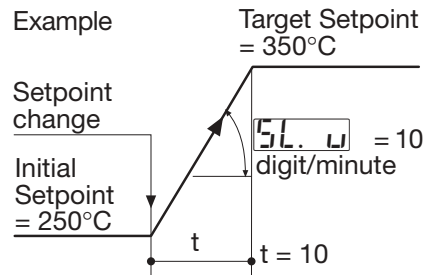

S.P.E.r**Stored Setpoint tracking**

(see chapter 4.3.2 at page 27)
Two different operation mode can be set:

A- Stand-by mode **00**

The memorised Setpoint is active until its command is active too. Then the controller goes back to the Local Setpoint which becomes the operating one.

B- Tracking mode **925**

Once the memorised Setpoint is active, it remains operating also when its command is not active anymore.

The previous Local Setpoint value will be lost.

r t 10**Remote Setpoint Ratio**

Ratio is the coeff. which defines the remote Setpoint span with respect to the input span.

b 125**Remote Setpoint**

Bias defines the starting point of analogue Remote Setpoint in eng. units corresponding to the low limit (current or voltage) of the remote signal.

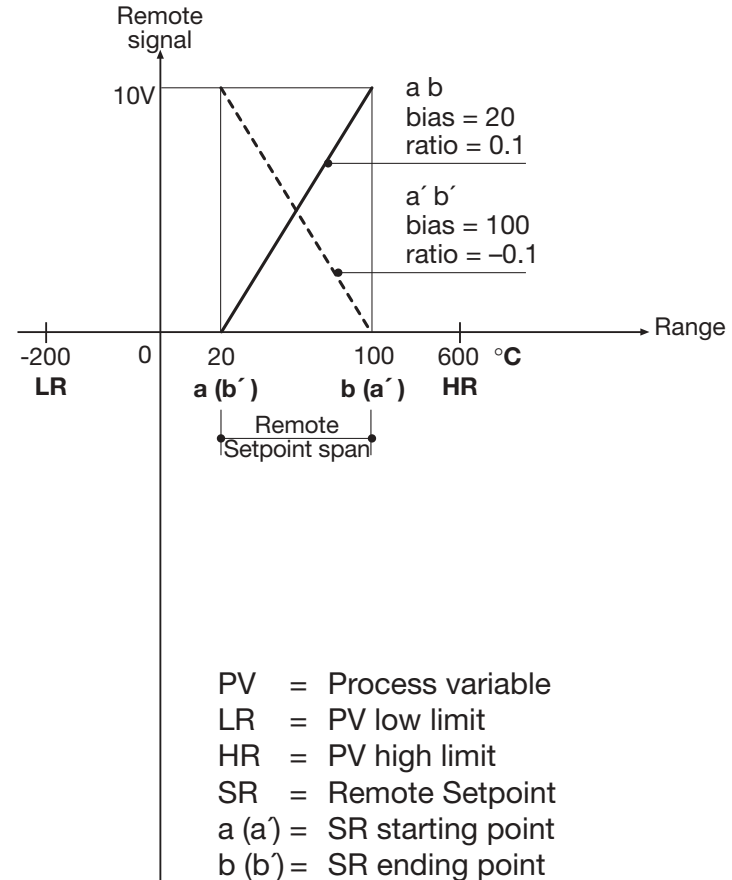
Remote Setpoint Bias and Ratio

4.5.1 SETPOINT MENU

If SR starting point is **lower** then the ending point, both expressed in engineering units:

b_{set} = starting point = a

$$r_{\text{trim}} = \frac{b - a}{HR - LR}$$

Example:

$b_{\text{set}} = 20$

$r_{\text{trim}} =$

$$\frac{100 - 20}{600 - (-200)} = \frac{80}{800} = 0.1$$

If SR starting point is **higher** then the ending point, both expressed in engineering units:

b_{set} = starting point = a'

$$r_{\text{trim}} = \frac{b' - a'}{HR - LR}$$

Example:

$b_{\text{set}} = 100$

$r_{\text{trim}} =$

$$\frac{20 - 100}{600 - (-200)} = \frac{-80}{800} = -0.1$$

Working Setpoint (SP) as combination of Local Setpoint (SL) and remote signal

Setpoint type *Local*
(table 3, page 27)

$$SP = SL + (r_{\text{trim}} \cdot REM) + b_{\text{set}}$$

Setpoint type *Remote*
(table 3, page 27)

$$SP = REM + (r_{\text{trim}} \cdot SL) + b_{\text{set}}$$

SIGN = Remote signal percentage

SPAN = HR-LR

$$REM = \frac{SIGN \cdot SPAN}{100}$$

Examples:

Local Setpoint (SL) with an external Trim with multiplying coeff. of 1/10:

Setpoint type = *Local*

$r_{\text{trim}} = 0.1$

$b_{\text{set}} = 0$

Remote Setpoint (SR) with an internal Trim with multiplying coeff. of 1/5:

Setpoint type = *Remote*

$r_{\text{trim}} = 0.2$

$b_{\text{set}} = 0$

Remote Setpoint range equal to the Input range:

Setpoint type = *Local*

$r_{\text{trim}} = 1$

$b_{\text{set}} = LR$

$SL = 0$

4.5.2 ALARM MENU

(see also pages 32 and 33)

h4_u

**Asymmetric
upper alarm
hysteresis**

h4_d

**Asymmetric
lower alarm
hysteresis**

Example with high absolute alarm

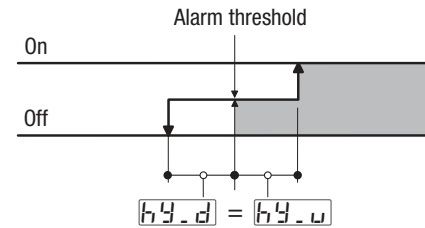

The parameter can be set between 0 and 5% of the configured Span and set in Engineering units. e.g.

Range = -200...600°C;

Span = 800°C;

Max Hysteresis = 5% 800° = 40°C;

For symmetrical hysteresis set

h4_d = h4_u

EF1

**Alarm
delay**

Delay time for alarm activation.
OFF: alarm activated immediately.
 1...9999: alarm activated only if the condition persists for the set time.

4.5.3 PID MENU

Not present with On-Off main output.

P.b.

**Proportional
Band**

P.b. C

**Cool Proportional
Band**

This parameter specifies the proportional band coefficient that multiplies the error (SP - PV).

E. I.

**Integral
Time**

E. I. C

**Cool integral
Time**

It is the integral time value, that specifies the time required by the integral term to generate an output equivalent to the proportional term. When **OFF** the integral term is not included in the control algorithm.

E.d.

**Derivative
Time**

E.d. C

**Cool Derivative
Time**

It is the time required by the proportional term P to reach the level of D. When **OFF** it is not included.

OC.

**Overshoot
control**

(Automatically disabled when the adaptive tune is running).
 This parameter specifies the span of action of the overshoot control. Setting lower values (1.00 → 0.01) the overshoot generated by a Setpoint change is reduced. The overshoot control doesn't affect the effectiveness of the PID algorithm. Setting 1, the overshoot control is disabled.

4.5.3 PID MENU

0.r.25

**Manual
reset**

This term specifies the value of the control output when $PV = SP$, in a PD only algorithm (lack of the Integral term).

d.E.r.r

**Error
Dead Band**

Inside this band for $(PV - SP)$, the control output does not change to protect the actuator (output Stand-by).

4.5.4 TUNING MENU

(not shown for ON-OFF main control output)

See page also 57

Two tuning method are provided:

- Initial one shoot **Fuzzy-Tuning**.
- Continuous, self learning **Adaptive Tuning**.

The **Fuzzy-Tuning** determines automatically the best PID term with respect to the process behaviour. The controller provides 2 types of “one shot” tuning algorithm, that are selected automatically according to the process condition when the operation is started.

STEP response

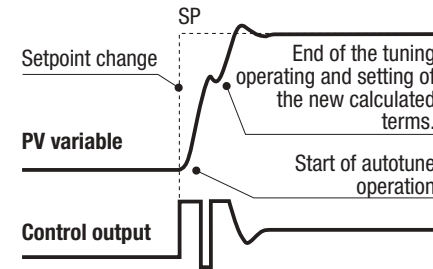

This type is selected when, at the start of the autotune operation, the PV is far from the Setpoint of more than 5% of the span. This method has the big advantage of fast calculation, with a reasonable accuracy in the term calculation.

Natural frequency

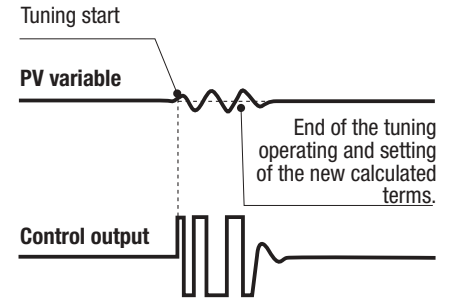

This type is selected when the PV is close to the SP Setpoint. This method has the advantage of a better accuracy in the term calculation with a reasonable speed calculation.

The Fuzzy Tuning determines automatically the best method to use to calculate the PID term, according the process conditions.

The self-learning **adaptive auto-tune** is not intrusive. It doesn't affect the process, at all, during the phase of calculation of the optimal terms parameters.

Continuous **adaptive tune**

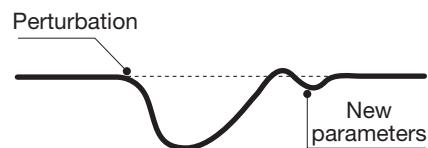

It is particularly suitable for controlling process whose control characteristics change with time or are not linear in relation to the Setpoint values. It doesn't require any operation by the user. It is simple and works fine: it samples continuously the process response to the various perturbations, determining the frequency and the amplitude of the signals. On the

basis of this data and their statistical values, stored in the instrument, it modifies automatically the PID term parameters.

It is the ideal for all applications where it is required to change continuously the PID terms parameters, in order to adjust the PID to the changes of the process dynamic conditions.

In case of power off with the Adaptive Tune enabled, the values of the PID terms parameters are stored, in order to be reused at the next power on.

At power on the Adaptive Tune starts automatically.

4.5.5 INPUT MENU

6.F 1L Input filter

Time constant, in seconds, of the RC input filter on the PV input. When this parameter is **OFF** the filter is bypassed.

Filter response

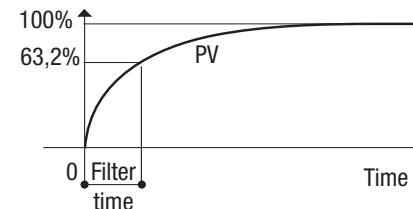

10.56 Measure Bias

This value is added to the measured PV input value. Its effect is to shift the whole PV scale of its value (± 60 digits).

6.500 Sampling Time

Sampling time, in seconds, of the instrument. This parameter is normally used when controlling slow process, increasing the sampling time from 0.1 to 10 seconds.

4.5.6 OUTPUT MENU

OP.HY Control output hysteresis

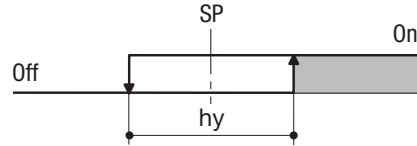

The parameter can be set between zero and 5% of the configured Span and set in Engineering units.

- e.g.
- Range = -200...600°C
- Span = 800°C
- Max Hysteresis = 5% 800° = 40°C

OP.C Control output cycle time

OP.C Cool cycle time

It's the cycle time of the logic control output. The PID control output is provided by the pulse width modulation of the waveform.

OP.L Control Output low limit

It specifies the minimum value of the control output signal. It is applied in manual mode, too.

OP.H Control output high limit

It specifies the maximum value the control output can be set. It is applied in manual mode, too.

OP.C.H Cool output high limit

OP.r Heat output maximum rate

OP.r C Cool output maximum rate

This value, specified in %/seconds, with range from 0.01 to 99.99%/s provides the maximum rate of change of the output. When set to **OFF** this function is disabled.

SE.OP Soft start of the control output

It specifies the value at which the control output is set during the start up phase.

SE.T Soft start time

This value specifies the time the start up phase lasts. The start up phase starts at power up of the controller.

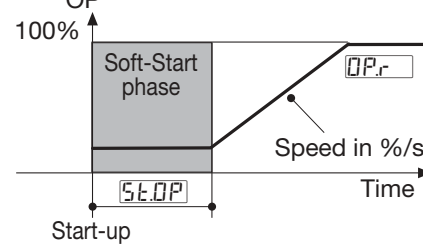

TR.T Travel time

It provides the time required to the motor positioner to go from the 0% position to 100%.

TR.HY Minimum step

It specifies the minimum allowed time of activation of the output to a motor positioner that produces a sensible effect. It is related to the deadband of the positioner.

dbnd Heat/Cool deadband

This parameter specifies the width of the deadband between the Cool and the Heat channel.

Heat / Cool Algorithm

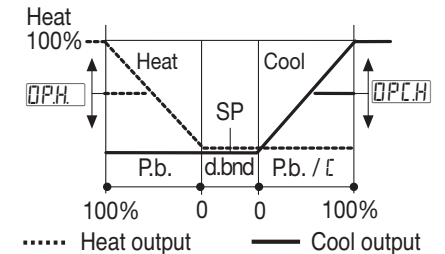

4.5.7 SERIAL COMMUNICATION MENU (OPTION)

Addr.S

SLAVE address communication
- 1...247

Addr.P

SLAVE Profibus DP address
- 3...124

All the instrument connected to the same supervisor must have different addresses.
If set `0FF` the serial comm.s is not active.

bdr.S

SLAVE Baud rate

bdr.M

MASTER Baud rate

It provides the baud rate in the range from 1.200 to 19.200 bit/s.

Par.Y

Parity

May be set even `E u E n` or odd `odd`.

If `nonP` is set, parity will be excluded.

Three serial comm.s options are available:

A - Modbus/Jbus SLAVE

The parameters value can be read and when possible modified.

B - Modbus/Jbus MASTER with Mathematical package

Mathematical package.

The transmission and inquiry of parameters value to all the devices using Modbus/Jbus SLAVE (e.g. PLC, etc.) is allowed.

The mathematical package can manipulate the received data by means the serial communications.

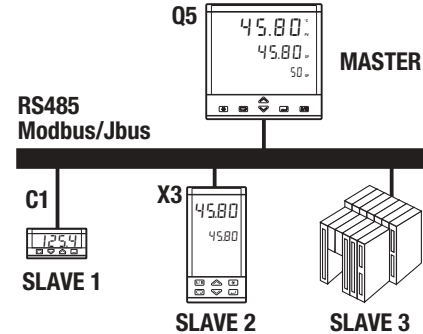

Example:

The MASTER (X5) reads the process variable from SLAVE 1 (C1) and SLAVE 2 (X3). It compares the two values and send the higher to the SLAVE 3 (PLC).

The available math. operations are:

+	-	*	/	>	<
---	---	---	---	---	---

To define the controller operations of this option, the configuration software must be used [1].

C - PROFIBUS DP SLAVE (Process Field bus protocol)

Industrial standard for peripheral devices connection to a machine in a plant.

The protocol installed in this controller, offers the following advantages against the standard normally supplied by other suppliers:

- Communications baudrate.
Up to 12 Mb/s with electric isolation.
- The list of data transfer (profile file) **is user configurable.**
It can be set by means the configuration software [1].

Notes:

[1] **⚠ Please, read the user manual:**

”**gammadue® and delatadue® controller series serial communication and configuration software**”.

4.6 PARAMETERISATION - ACCESS MENU - PASSWORD - CALIBRATION

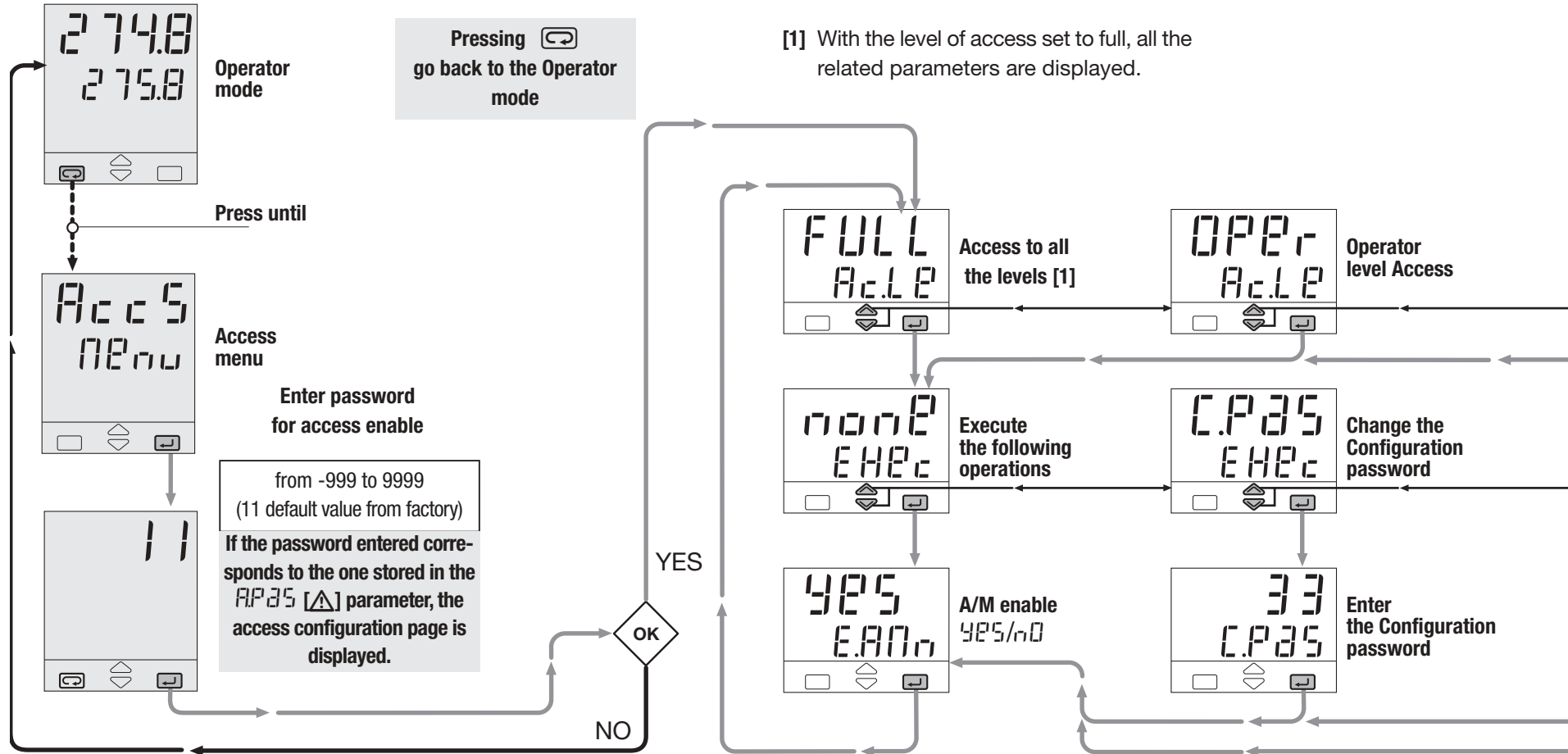

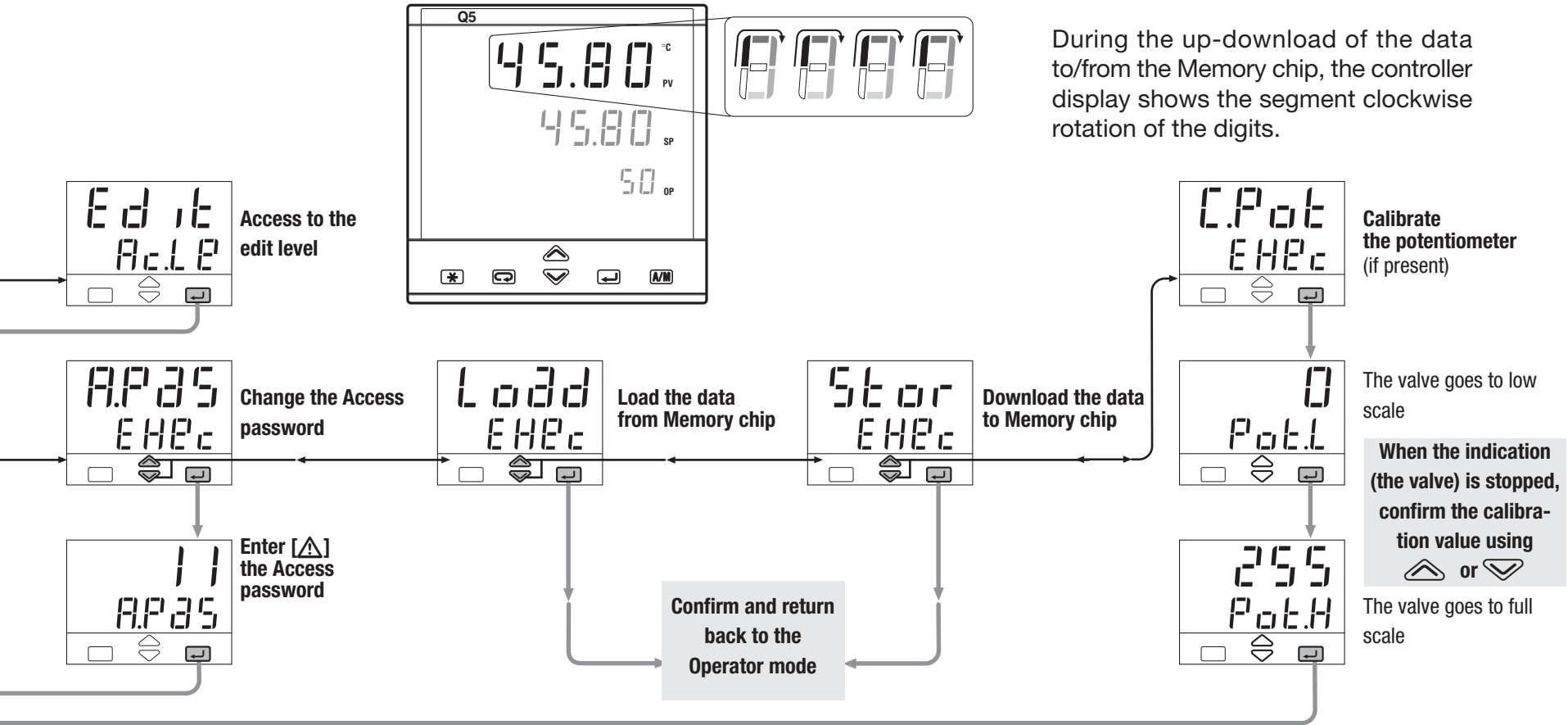



4.6 PARAMETERISATION - ACCESS MENU - PASSWORD - CALIBRATION

With the access level **Edit**, the user defines which groups and parameters are accessible to the operator

After selecting and confirming the access level **Edit**, enter in the parameters menu. The code of the access level is displayed on the front panel.

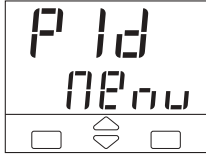
Press the   keys to select the proper level.

Group of parameters	Code	Access level
	rEd	Visible
	HiDE	Not visible

Group of parameters	Code	Access level
	AlEr	Visible and changeable
	FaSt	Included in "Fast view"
	rEd	Visible only
	HiDE	Not visible and not changeable

The parameters in the access level **FaSt** are recalled on the front panel through the procedure of **fast parameter access** illustrated in par. 5.2 page 53. The maximum number of fast parameters is 10.

At the end of the parameter list of the selected group, the controller quits from the **Edit** access level.

Therefore, the Edit level must be selected for each group of parameters

The access level of groups and parameters, is activated through

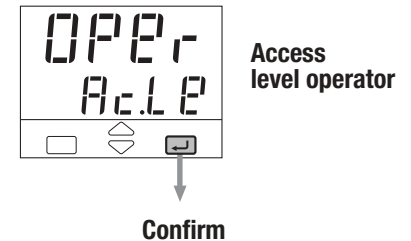

5 DISPLAYS 5.1 STANDARD DISPLAY

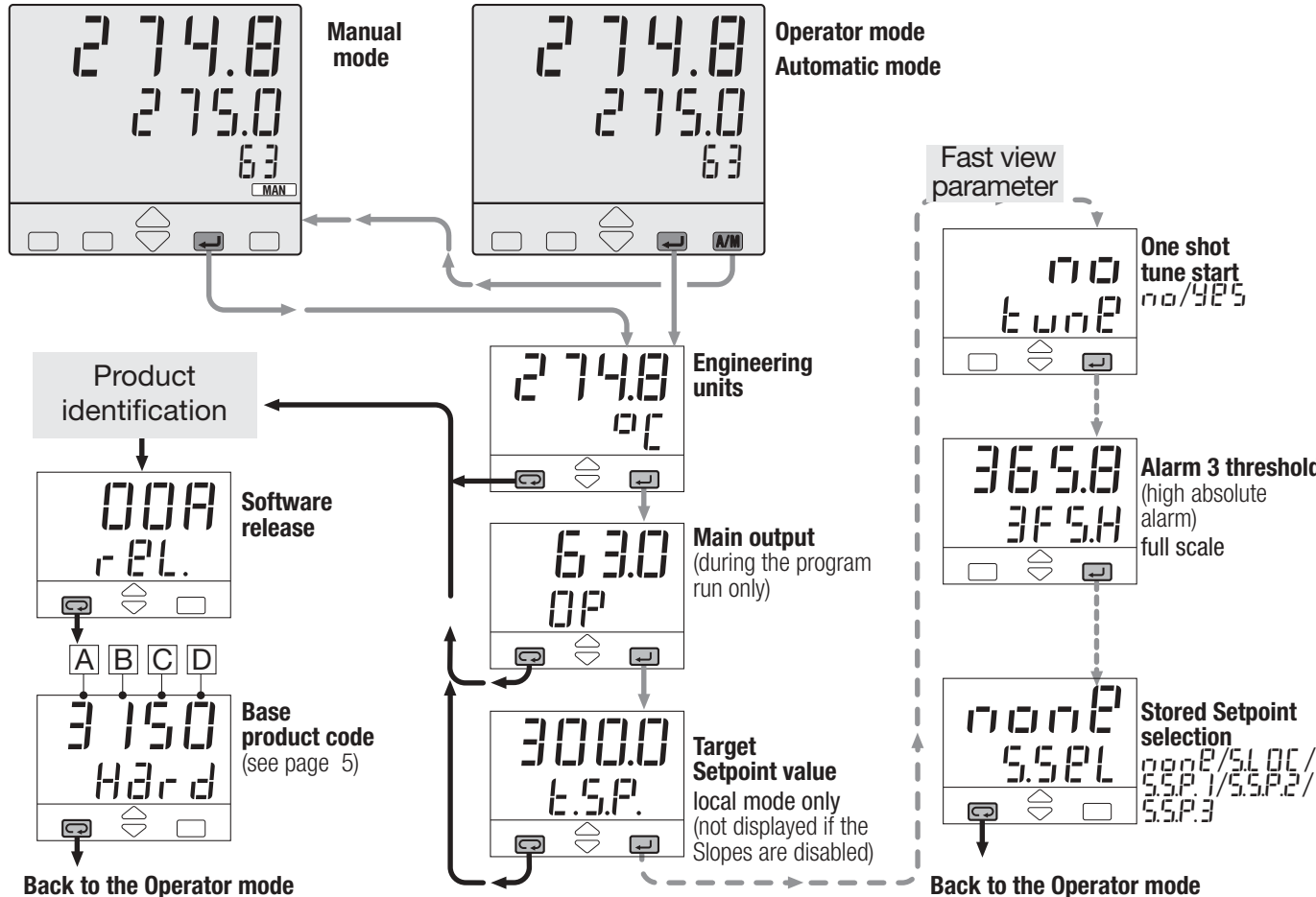

5.2 FAST VIEW (fast access to the parameters)

With this procedure, simple and fast, up to 10 parameters, selected through the fast view (see par 4.6 page 52) **are displayed and can be modified by the operator without requiring the standard parameter setting procedure.**

Press in order to modify the parameters
The value is entered by pressing key.

On left side, please find as an example a list of parameters on Fast view menu.

6 COMANDS

COMMANDS TO THE CONTROLLER AND OPERATING PHASES

The commands can be entered in 3 ways:



6.1 KEYPAD

see page 55

- Setpoint modification;
- Manual mode;
- Local/remote selection;
- Stored Setpoint display;
- Tune Run / Stop;
- Program start/stop (see page 66).

6.2 DIGITAL INPUTS

see page 58

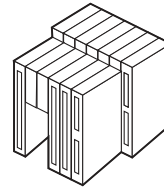



6.3 SERIAL COMMUNICATIONS

see the manual on this topic



6.1 KEYPAD COMMANDS

6.1.1 SETPOINT MODIFICATION

The **Setpoint** is directly modified with the   keys. Once entered, the new value is checked and becomes operating after 2 seconds. The end of this phase is flagged by flashing momentarily the display with SP.

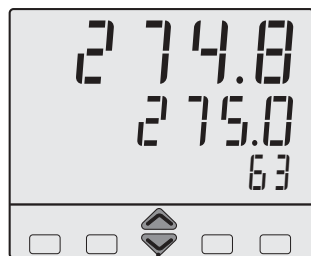

Operator mode

Example of Setpoint modification from 275.0 to 350.0

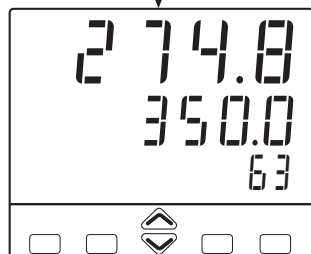

Modified Setpoint value

 after 2 seconds

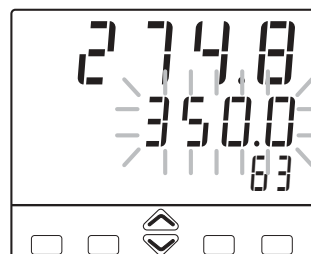

Flash momentarily the SP value to **confirm** that it has become operating. Back to the operator mode

6.1.2 AUTO/MANUAL MODE

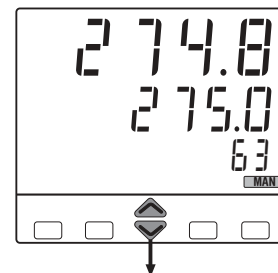

Select manual green **MAN** led on

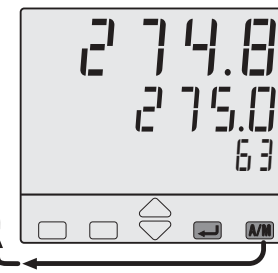

Operator mode
(automatic)

Modification of control output value

 The new value is immediately working without any confirm.

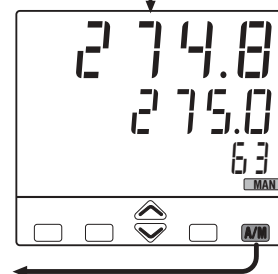

Modify the output value

Back to the operator mode

The bumpless action is present switching between AUTO, MAN and vice versa.

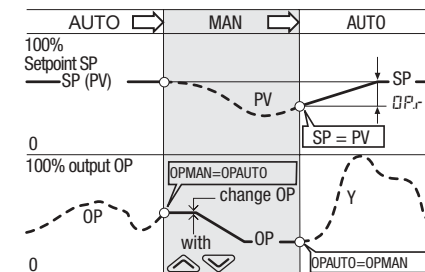

 In case of power failure, the AUTO/MAN status and the output value remain stored in the controller memory.

6.1.3 LOCAL/ REMOTE SELECTION

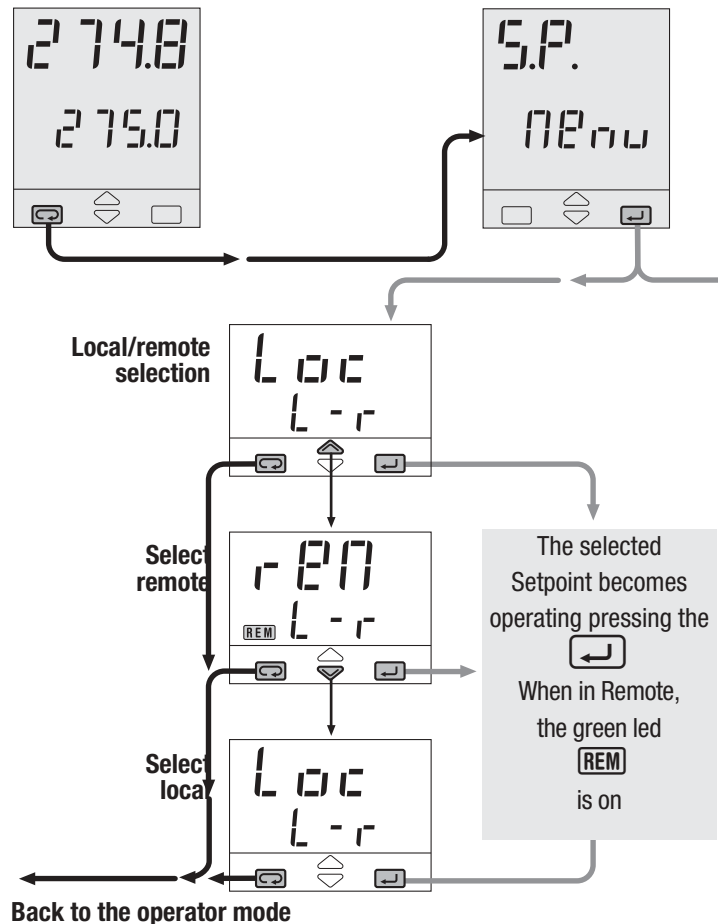

6.1.4 STORED SETPOINTS SELECTION (see also pages 42, 43)

The Setpoint is directly modified with the keys. Once entered, the new value is checked and becomes operating after 2 seconds. The end of this phase is flagged by flashing momentarily the display with SP.

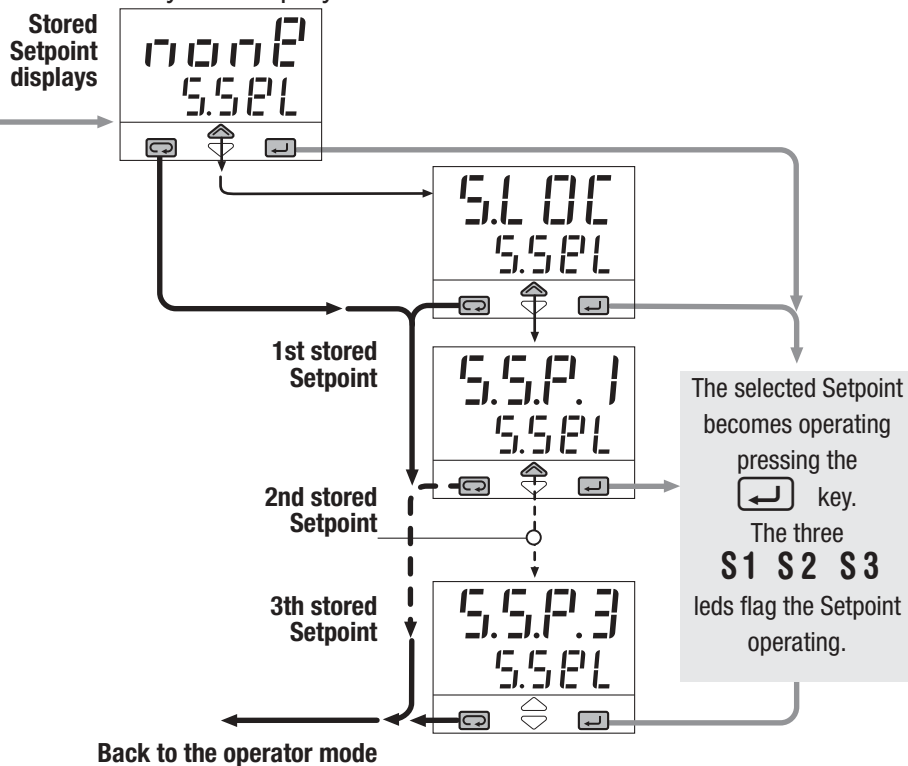

6.1.5 TUNE RUN / STOP

This controller is provided with 2 different Tuning algorithm:

- **Fuzzy tune (one shot tune)** for calculating the optimal PID terms parameters.
- **Adaptive Tune** (continuous tune) for a continuous calculation of the PID terms parameters.

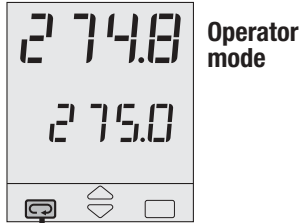

press until

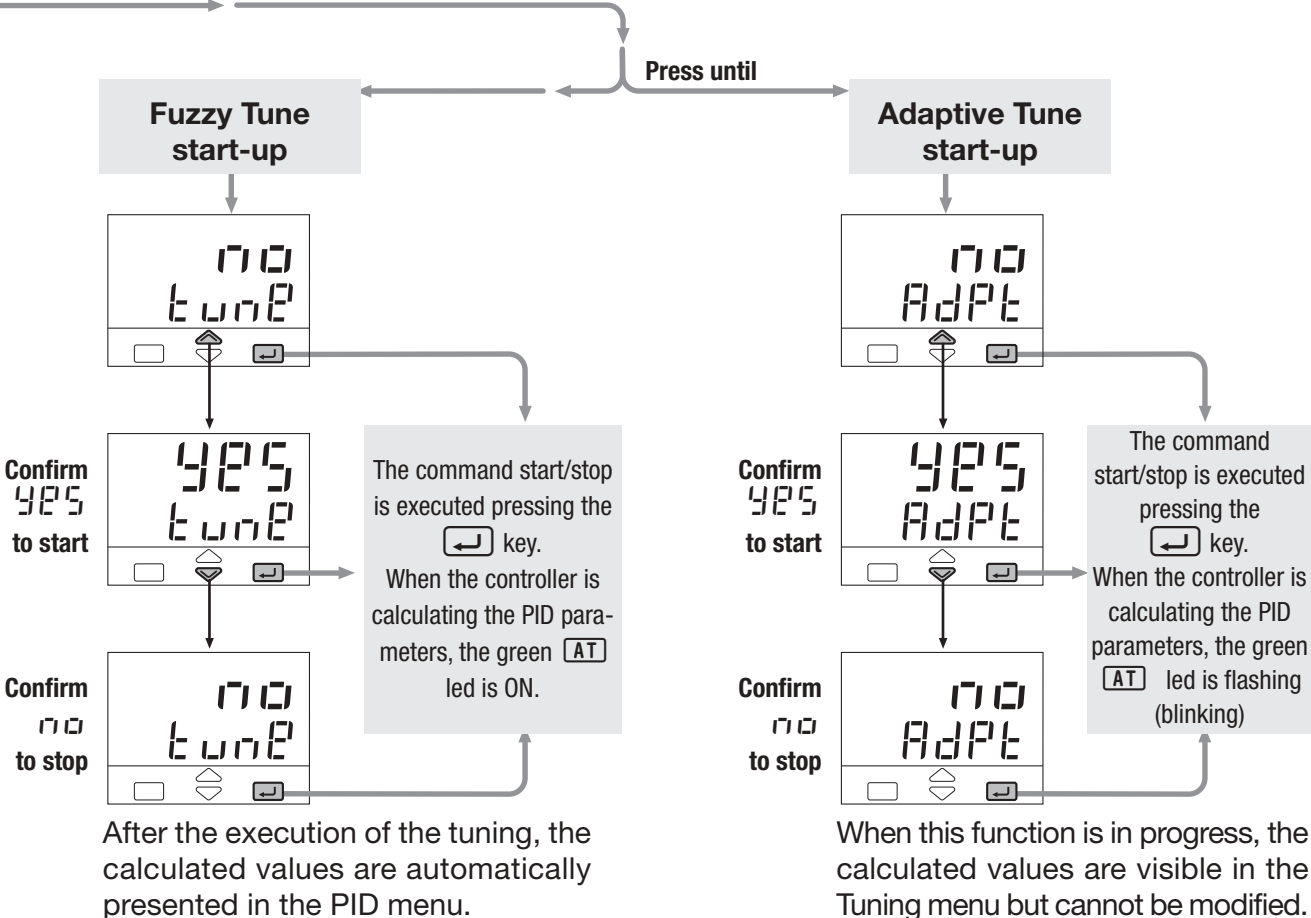
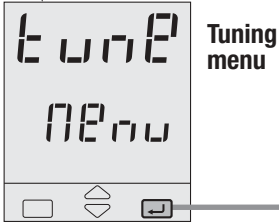

After the execution of the tuning, the calculated values are automatically presented in the PID menu.

When this function is in progress, the calculated values are visible in the Tuning menu but cannot be modified.











6.2 DIGITAL INPUTS COMMANDS

A function is assigned, through the configuration procedure to each IL1, IL3 and IL3 digital input. (see the parameters setting at tab. 10 at page 30).

The configured function is activated when the digital input (free voltage contact or open collector output) is in the On state (closed). It is deactivated by setting the input to the Off state (open).

The activation of the function through the digital input has the highest priority than through the keypad or through the serial communication.

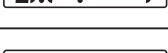
6.2.1 DIGITAL INPUTS COMMANDS FOR LOCAL-REMOTE SETPOINT

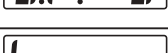
Function	Parameter value	Performed operation		Notes
		 Off	 On	
None		—	—	Not used
Set manual mode		Automatic	Manual	
Keyboard lock		Unlock	Locked	With the keypad locked the commands from digital inputs and serial communications are still operating
PV measure hold		Normal operation	PV is hold	The value of PV is “frozen” at the time the digital input goes to the close state
Setpoint slopes inhibition		Rate limiting is active	Normal operation	When the input is in the on state, the Setpoint is changed in steps
Output forcing mode		Normal output	Forced output	With ON command the output is equal to the forced value (see page 28)
1st stored Setpoint		Local	1st SP	The permanent closure forces the chosen stored value. Setpoint modification is not possible.
2nd stored Setpoint		Local	2nd SP	The impulsive closure, selects the stored value. Setpoint modification is allowed.
3th stored Setpoint		Local	3th SP	If more than one digital input is selecting a Setpoint, the last to be activated is the operating one. (see page 43)
Set Remote mode		Local	Remote	
Reactivation of blocking		—	Reactivation of blocking	The blocking function is activated on closing the command from digital inputs

7 PROGRAMMED SETPOINT

INTRODUCTION

When the Setpoint programmer option (mod. Q5-3... **4**) is present, up to four programs are available.

MAIN CHARACTERISTICS

- 4 program, 16 segments max/program;
- start, stop, hold etc, commands from the keypad;
- time base in seconds, minutes or hours;
- continuous or up to 1...9999 time cycling of the program;
- two digital outputs (OP3 and OP4) related to the program;
- setting of the maximum allowed deviation from the Setpoint.

7.1 PROGRAM STRUCTURE

The program consists of a sequence of segments.

For each segment, it is specified:

- the Setpoint to reach
 - the duration of the segment
 - the state of the OP3 output.
- } always present

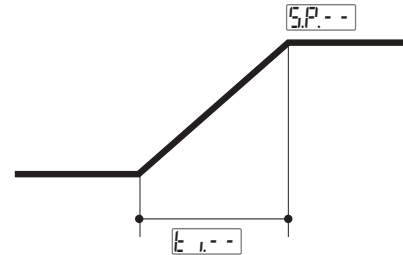

The program consists of:

- 1 initial segment named \square ;
- 1 end segment named F ;
- 1...14 normal segments.

Initial segment - \square

Its main purpose is to define the value the process variable has to maintain before starting the program.

End segment - F

Its main purpose is to define the value the process variable has to maintain at the end of the program and until further changes of Setpoint.

Normal segments - - - -

These segments build up the profile program. There are 3 types of segments:

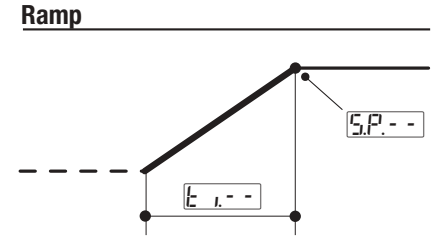

Dwell

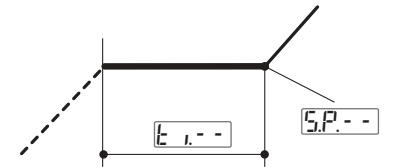

Step

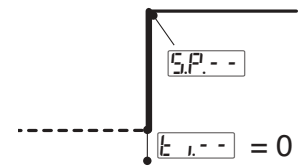

S.P. = Target Setpoint

t. i. = Duration

----- = Previous segment

————— = Current segment

————— = Next segment

EXAMPLE OF SETPOINT PROFILE

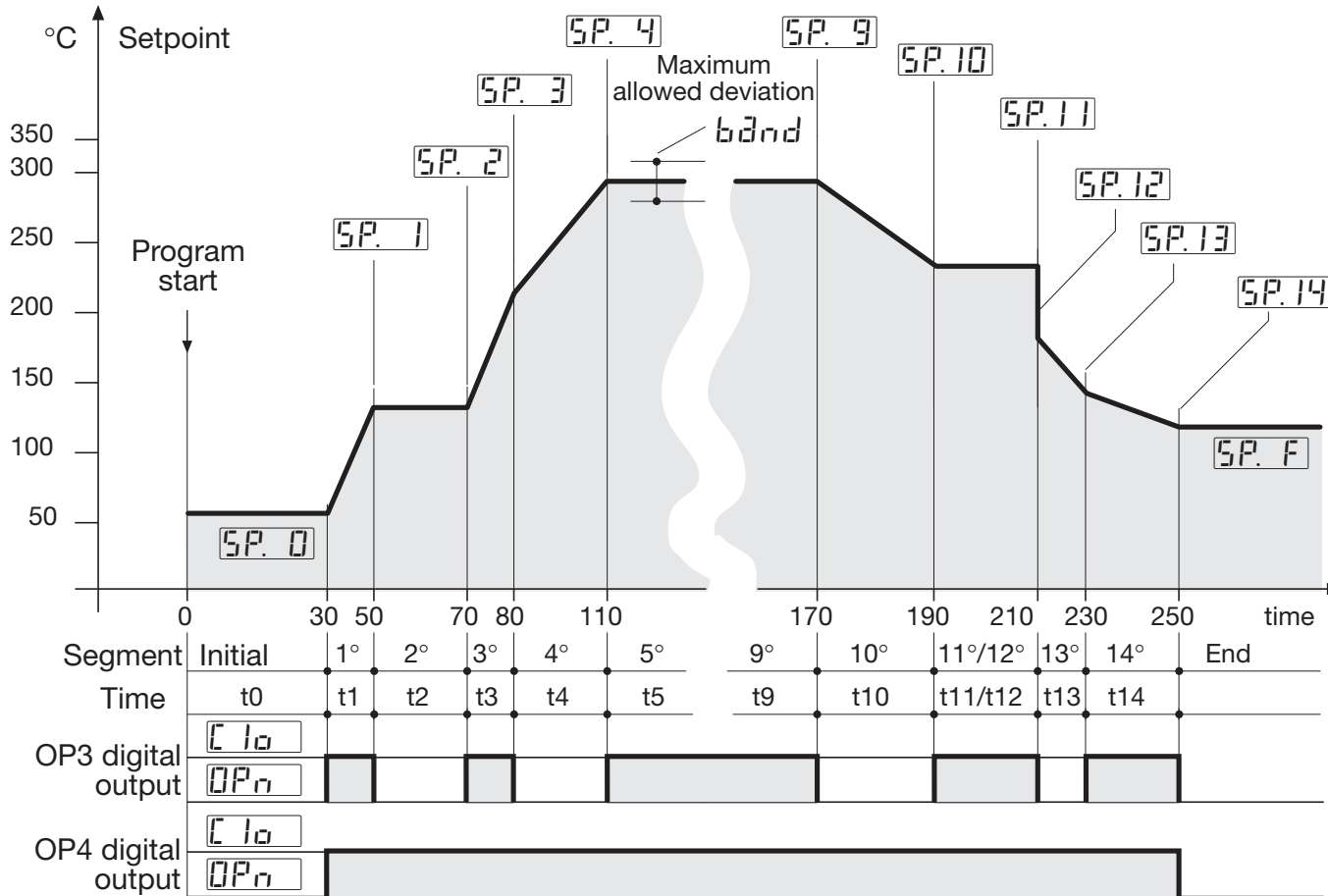

7.2 SETPOINT PROGRAMMER

7.2.1 MAXIMUM ALLOWED DEVIATION (band)

If the PV controlled input value exceeds the band, centred around the SP, the segment time is extended of the same time the PV input stays out of the band. The band width is defined in a parameter of the program segment. The actual segment period is calculated as $t_{i-} + t_i$.

OPERATION

A. Ramp

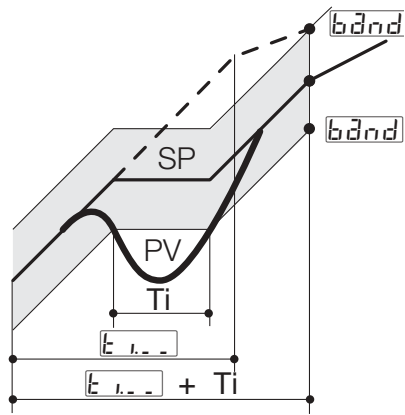

B. Dwell

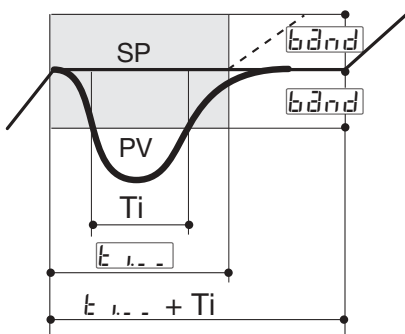

7.2.2 RE-START OF A PROGRAM AFTER A POWER FAILURE

The parameter `FAIL` specifies the behaviour of the programmer at power up (see page 62). Selected between the following 3 choices:

`Cont` Continue

`rES` Reset

`rAMP` Ramp

If `Cont` is selected, the execution of the program starts from the point reached at the power failure time.

All the parameters, like Setpoint and the remaining time are restored at the values they had at power off.

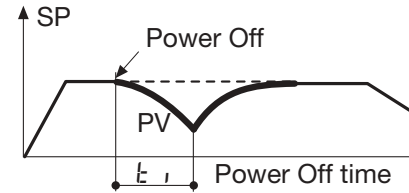

If `rES` is selected,

at power on the program ends and goes back to local mode.

If `rAMP` is selected, the execution of the program starts from the point reached at the power failure time.

In this case, the programs continue with PV reaching SP with a ramp, whose slope corresponds to the one of the segment running at the power off.

Power off during a dwell

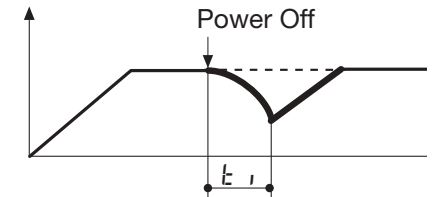

Power off during a ramp

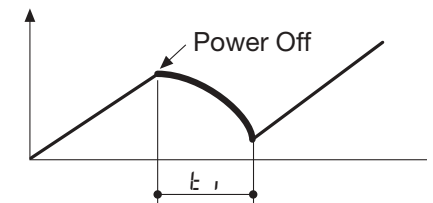

7.3 PARAMETERISATION - PROGRAM MENU (OPTION)

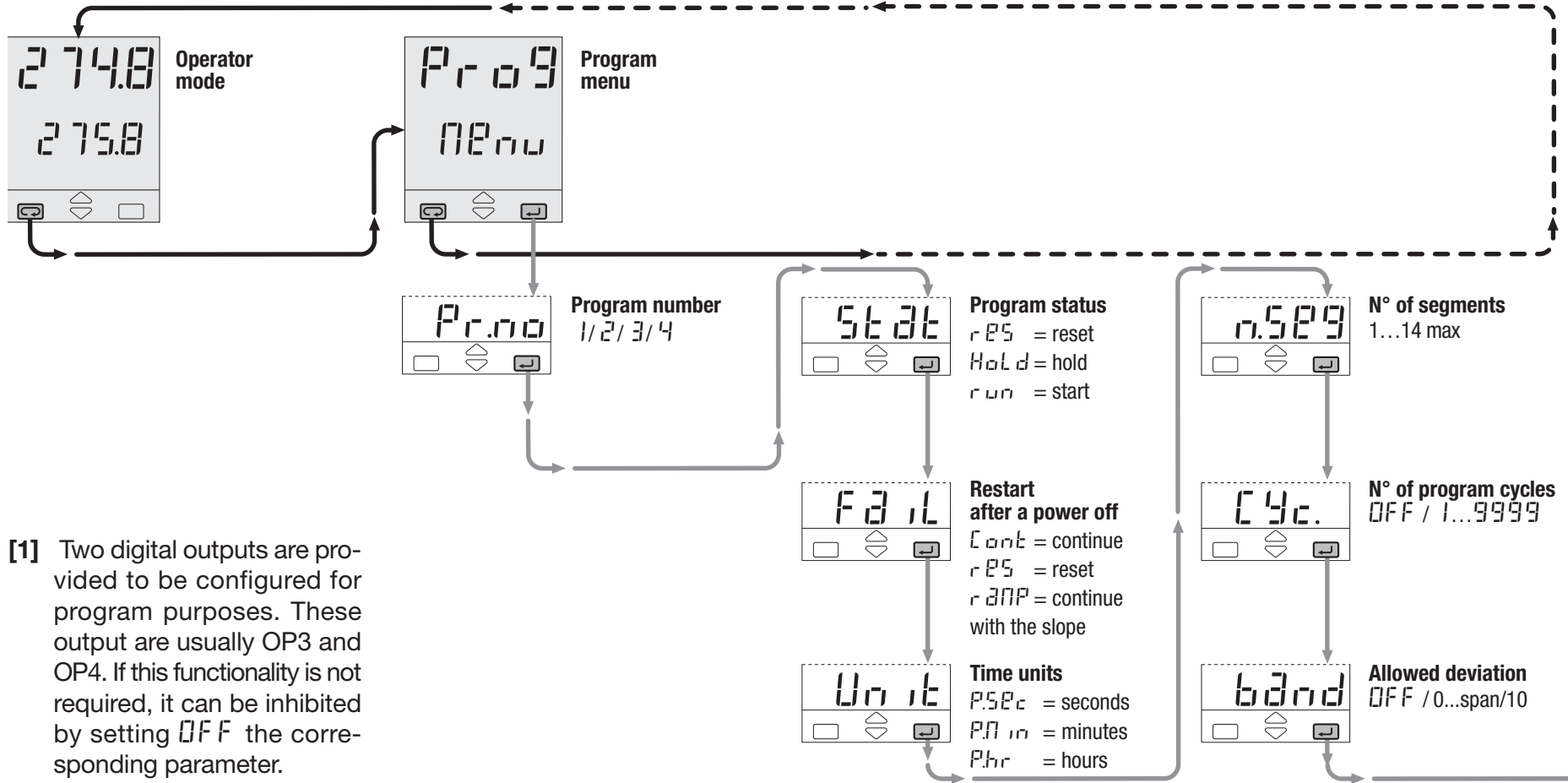

- [1] Two digital outputs are provided to be configured for program purposes. These output are usually OP3 and OP4. If this functionality is not required, it can be inhibited by setting **OFF** the corresponding parameter.

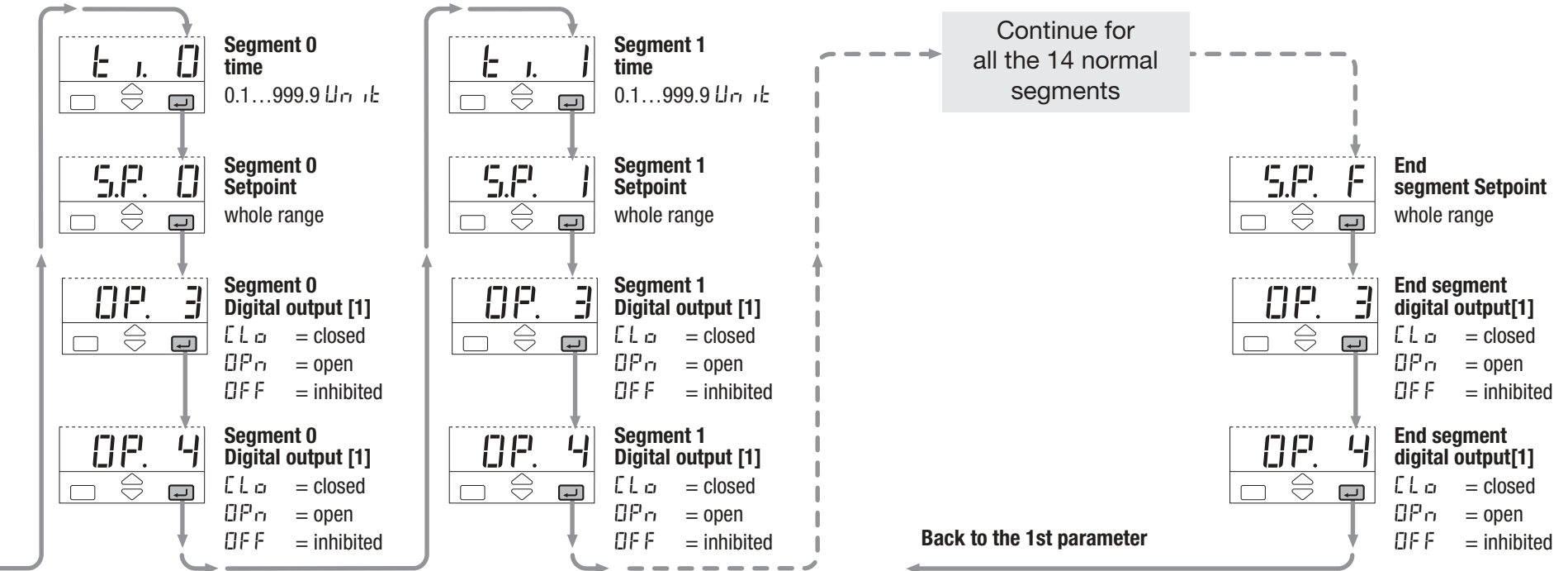

7.4 PROGRAM STATUS DISPLAYING

The function mode of the program as well its status is displayed clearly by means the **RUN** and **HLD**; leds as follows:

Function	Status	Led	
		RUN	HLD
Local	Reset	OFF	OFF
Program run	Run	ON	OFF
Program hold	Hold	ON	ON
Program hold for PV outside Error band	Hold back	ON	ON
Program end (reset)	End	ON	OFF

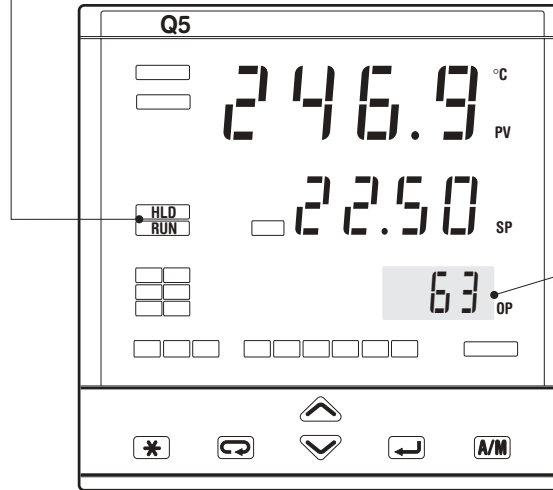

On program run mode, each 3 s the display shows alternatively:

- number of running program;
- number of operating segment as well its status.

The control output value can be displayed during the program run using the procedure at page 53.

P 3 Number of running Program (program n° 3)

each 3 s **Operating segment and its status**

12 1 (Segment n°12) - ramp up

12 4 (Segment n°12) - ramp down

12 3 (Segment n°12) - dwell

F 3 (End segment) **Program end**

7.5 START/STOP OF A PROGRAM

The various commands, supported by the controller, are different for each of the following operating phases:

- A] when in Local Setpoint mode
- B] during the execution of a program;
- C] when the program is in hold.

Commands supported by the controllers.

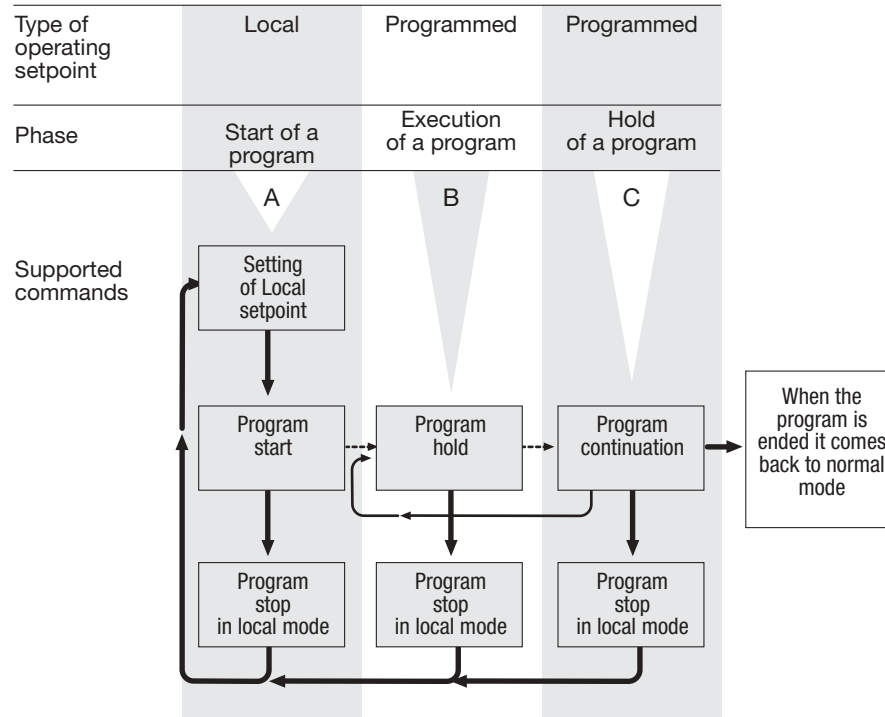

The different phase are displayed in a chained way, just for easing the understanding of the functionality.

Two different mode for starting and stopping a program are provided:

- direct mode with the  key (see page 66).
- through the parameter menu (see page 67).

7.5.1 START/STOP OF A PROGRAM BY DIRECT MODE WITH *

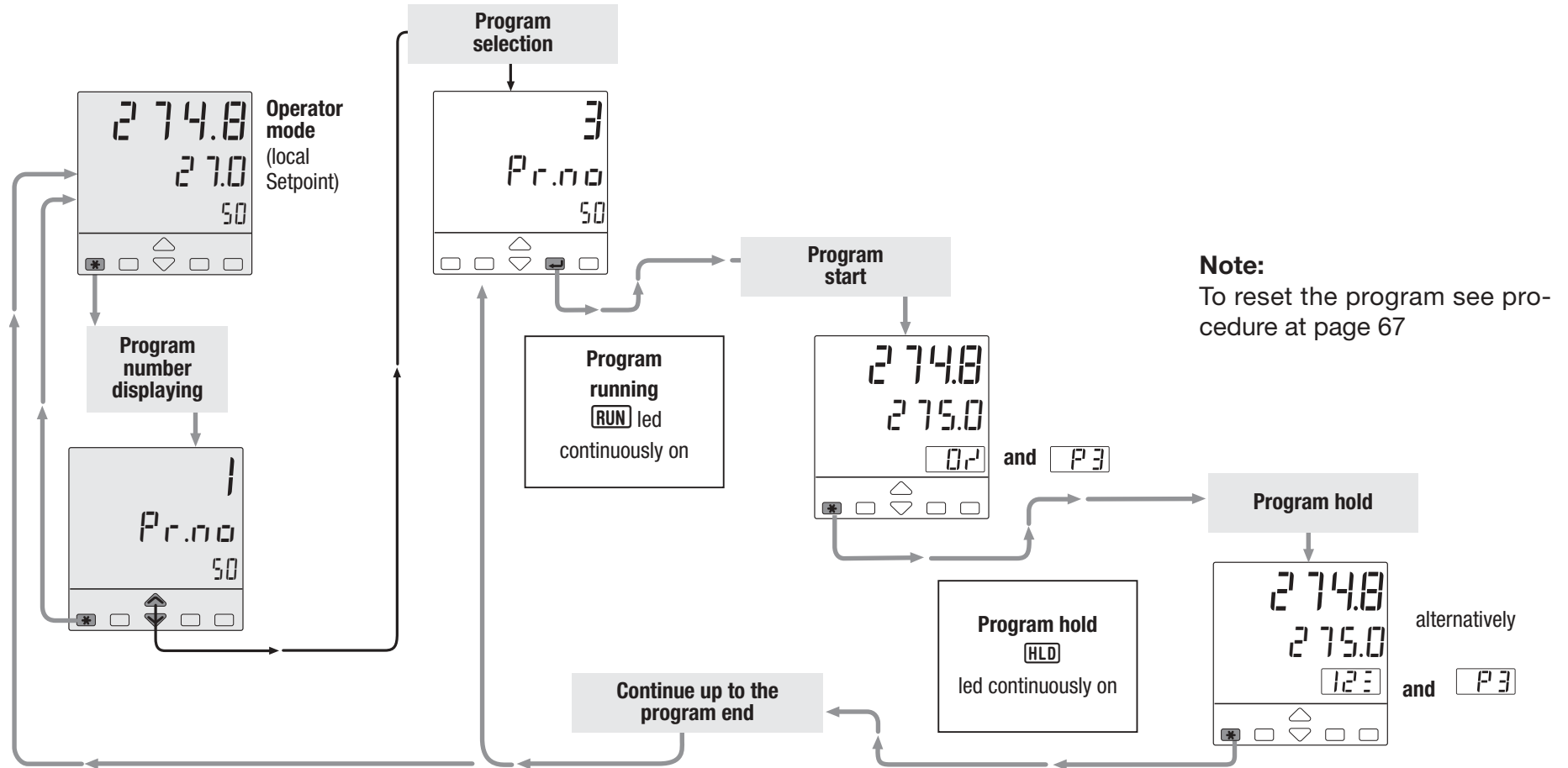

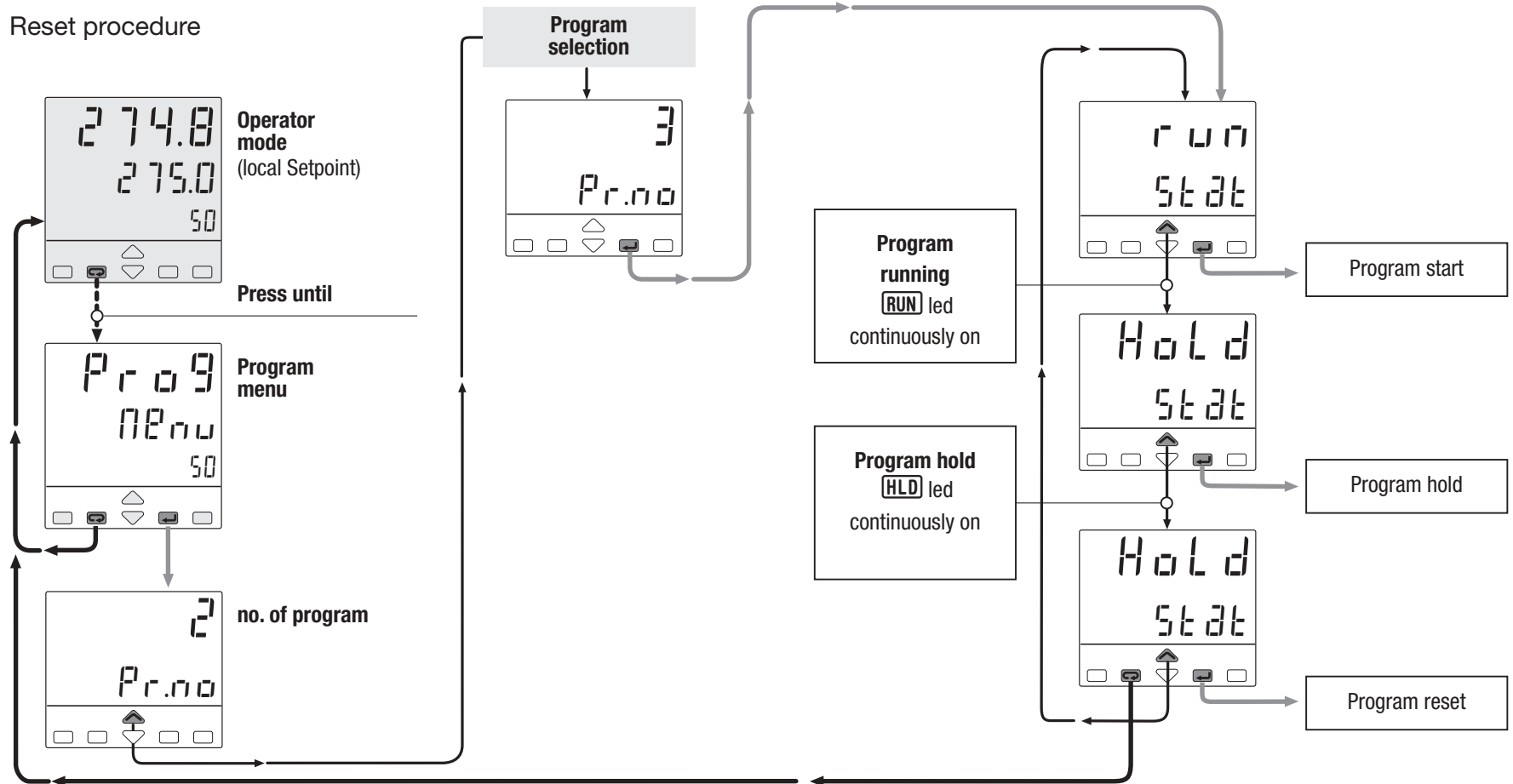

7.5.2 START/HOLD/STOP OF A PROGRAM THROUGH THE PARAMETER MENU

Reset procedure



7.5.3 DIGITAL INPUT COMMANDS FOR SETPOINT PROGRAMMER FUNCTION (OPTION)

Function	Parameter value	Performed operation		Notes
		 Off	 On	
None	OFF	—	—	Not used
Set manual mode	MAN	Automatic	Manual	
Keyboard lock	KEYL	Unlock	Locked	With the keypad locked the commands from digital inputs and serial communications are still operating
PV measure hold	PHV	Normal operation	PV is hold	The value of PV is “frozen” at the time the digital input goes to the close state
Setpoint slopes inhibition	SLIP	Rate limiting is active	Normal operation	When the input is in the on state, the Setpoint is changed in steps
Output forcing	FORC	Normal operation	Forced output value	Digital input ON means activation forcing output value (see page 28)
1 st Program selection	Pr 9.1	Local	1 st program	Program selection by permanent closure of the digital input
2 nd Program selection	Pr 9.2	Local	2 nd program	
3 rd Program selection	Pr 9.3	Local	3 rd program	
4 th Program selection	Pr 9.4	Local	4 th program	
Program Start/Hold	r.-H.	HOLD	RUN	When the input is in the On state, the program is executed up to the end. When off, the program is forced in hold.
Program reset	rSt	Normal operation	Program reset	Digital input ON means program reset and control switching to Local setpoint
Deactivation of blocking	BLCK	—	Reactivation of blocking	The blocking function is activated at the time the digital input goes to the close state
Next segment	next	—	Skips to the next segment	The program skips to the next segment of the program at the time the digital input goes to the close state

8 TECHNICAL SPECIFICATIONS

Features at 25°C env. temp.	Description			
Total configurability (see chapter 4.3 page 25)	From keypad or serial communication the user selects: <ul style="list-style-type: none"> - the type of Setpoint - the type of control algorithm - the type of input <ul style="list-style-type: none"> - the type and functionality of the alarms - control parameter values - access levels 			
PV Input (see pages13,14 and page 26)	Common characteristics A/D converter with resolution of 160,000 points Update measurement time: 50 ms Sampling time: 0.1 ... 10.0 s Configurable Input shift: -60 ... +60 digit Input filter with enable/disable: 0.1 ... 99.9 seconds			
	Accuracy	0.25% ±1 digits for temperature sensors 0.1% ±1 digits (for mV and mA) Between 100...240Vac the error is minimal		
	Resistance thermometer (for ΔT: R1+R2 must be <320Ω)	Pt100Ω a 0°C (IEC 751) °C/°F selectable	2 or 3 wires connection Burnout (with any combination)	Max. wire Res: 20Ω max. (3 wires) Input drift: 0.1°C/10° T _{env} <0.1°C/10Ω Wire Res.
	Thermocouple	L, J, T, K, S, R, B, N, E, W3, W5 (IEC 584) R _j >10MΩ °C/°F selectable	Internal cold junction compensation con NTC Error 1°C/20°C ±0.5°C Burnout	Line: 150Ω max. Input drift: <2μV/°C. T _{env} . <5μV/10Ω Wire Res.
	DC input (current)	4... 20mA, 0... 20mA R _j =30Ω		Input drift: <0.1%/20°C T _{env} . <5μV/10Ω Wire Res.
	DC input (voltage)	0... 50mV, 0... 300mV R _j >10MΩ		
		1... 5, 0-5, 0... 10V R _j >10KΩ		
Frequency (option) 0... 2,000/0... 20,000Hz	Low level ≤2V High level 4... 24V		(min. range of 100 digits)	

Features at 25°C env. temp.	Description									
Auxiliary inputs	Remote Setpoint Not isolated accuracy 0.1%	Current 0/4...20mA: Rj = 30Ω	Bias in engineering units and ± range Ratio: -9.99... +99.99 Local + Remote Setpoint							
		Voltage 1... 5, 0...5, 0...10V: Rj = 300kΩ								
	Potentiometer	100Ω... 10KΩ	Feedback valve position							
Digital inputs 3 logic	The closure of the external contact produces any of the following actions: Auto/Man mode change, Local/Remote Setpoint mode change, 3 Stored Setpoint activation, keyboard lock, measure hold, slope inhibit and output forcing Program Hold/Run (if option installed), Program Selection and Skip to Next Segment									
Operating mode and Outputs	1 single or double action PID loop or On/Off with 1, 2, 3 or 4 alarms	Single action	Control output Main (Heat) Secondary (Cool)		Alarm AL1	Alarm AL2	Alarm AL3	Alarm AL4	Retransmission PV / SP	
			OP1 Relay/Triac			OP2 Relay/Triac	OP3 Relay	OP4 Relay	OP5 Analog./Digital	OP6 Analog./Digital
			OP5 Analog./Digital		OP1 Relay/Triac	OP2 Relay/Triac	OP3 Relay	OP4 Relay		OP6 Analog./Digital
		Double action Heat / Cool	OP1 Relay/Triac	OP2 Relay/Triac			OP3 Relay	OP4 Relay	OP5 Analog./Digital	OP6 Analog./Digital
			OP1 Relay/Triac	OP5 Analog./Digital		OP2 Relay/Triac	OP3 Relay	OP4 Relay		OP6 Analog./Digital
			OP5 Analog./Digital	OP2 Relay/Triac	OP1 Relay/Triac		OP3 Relay	OP4 Relay		OP6 Analog./Digital
		Valve drive	OP1 Relay/Triac	OP2 Relay/Triac			OP3 Relay	OP4 Relay	OP5 Analog./Digital	OP6 Analog./Digital

Features at 25°C env. temp.	Description			
Control mode	Algorithm	PID with overshoot control or On-off - PID with valve drive algorithm, for controlling motorised positioners		
	Proportional band (P)	0.5...999.9%		
	Integral time (I)	1...9999 s	DFF = 0	Single action PID algorithm
	Derivative time (D)	0.1...999.9 s		
	Error dead band	0.1...10.0 digit		
	Overshoot control	0.01...1.00		
	Manual reset	0...100%		
	Cycle time (Time proportional only)	0.2...100.0 s		
	Min./Max output limits	0...100% separately adjustable		
	Control output rate limit	0.01...99.99%/s	DFF = 0	
	Soft-start output value	1...100% - Time 1...9999 s		
	Output safety value	-100...100%		
	Control output forcing value	-100...100%		
	Control output hysteresis	0...5% Span in engineering units		On-Off algorithm
	Dead band	0.0...5.0%		Double action PID algorithm (Heat / Cool)
	Cool proportional band (P)	0.5...999.9%		
	Cool integral time (I)	1...9999 s	DFF = 0	
	Cool derivative time (D)	0.1...999.9 s		
	Cool cycle time (Time proportional only)	0.2...100.0 s		
	Control output high limit	0...100%		
	Cool output max. rate	0.01...99.99%/s	DFF = 0	
Motor travel time	15...600 s		Valve drive PID algorithm Raise/Stop/Lower	
Motor minimum step	to 0.1...5.0%			
Feedback potentiometer	100Ω ...10KΩ			

Features at 25°C env. temp.		Description				
OP1-OP2 outputs		SPST Relay N.O., 2A/250Vac (4A/120Vac) for resistive load Triac, 1A/250Vac for resistive load				
OP3 output		SPDT relay N.O., 2A/250Vac (4A/120Vac) for resistive load				
OP4 output		SPST relay N.O. 2A/250Vac (4A/120Vac) for resistive load				
Analogue/digital OP5 and OP6 (option) outputs		Control or PV/SP retransmission	Galvanic isolation: 500Vac/1 min Short circuit protected Resolution: 12 bit Accuracy: 0.1 % Analogue: 0/1... 5V, 0...10V, 500Ω/20mA max., 0/4... 20mA, 750Ω/15V max. Digital: 0/24Vdc ±10%; 30mA max. for solid state relay			
AL1 - AL2 - AL3 - AL4 alarms		Hysteresis 0...5% Span in engineering units				
		Action	Active high	Action type	Deviation threshold	±range
			Active low		Band threshold	0... range
		Special functions	Sensor break, heater break alarm			
			Acknowledge (latching), activation inhibit (blocking)			
Connected to Timer or program (if options installed) (only OP3-OP4)						
Setpoint		Local + 3 memorised		Up and down ramps 0.1...999.9 digit/min or digit/hour (OFF=0) Low limit: from low range to high limit High limit: from low limit to high range		
		Remote only				
		Local and Remote				
		Local with trim				
		Remote with trim				
		Programmable	If option installed			

Features at 25°C env. temp.	Description		
Programmable Setpoint (optional)	4 programs, 16 segments (1 initial and 1 end) From 1 to 9999 cycles or continuous cycling (FFF) Time values in seconds, minutes and hours Start, stop, hold, etc. activated from the keypad, digital input and serial communications		
Tuning	Fuzzy-Tuning type . The controller selects automatically the best method according to the process conditions	Step response Natural frequency	
	Adaptive Tune self-learning, not intrusive, analysis of the process response to perturbations and continuously calculation of the PID parameters		
Auto/Man station	Standard with bumpless function, by keypad, digital input or serial communications		
Serial comm. (option)	RS485 isolated, SLAVE Modbus/Jbus protocol, 1,200, 2,400, 4,800, 9,600, 19,200 bit/s, 3 wires RS485 isolated, MASTER Modbus/Jbus protocol, 1,200, 2,400, 4,800, 9,600, 19,200 bit/s, 3 wires RS485 asynchronous/isolated, PROFIBUS DP protocol, from 9600 bit/s at 12MB/s selectable, max lenght 100m (at 12 Mb/s)		
Auxiliary Supply	+24Vdc \pm 20% 30mA max. - for external transmitter supply		
Operational safety	Measure input	Detection of out of range, short circuit or sensor break with automatic activation of the safety strategies and alerts on display	
	Control output	Safety and forcing value -100...100% separately adjustable	
	Parameters	Parameter and configuration data are stored in a non volatile memory for an unlimited time	
	Access protection	Password to access the configuration and parameters data - Fast wiew	
General characteristics	Power supply (fuse protected)	100... 240Vac (-15...+10%) 50/60Hz or 24Vac (-25...+12%) 50/60Hz and 24Vdc (-15...+25%)	Power consumption 5W max.
	Safety	Compliance to EN61010-1 (IEC 1010-1), installation class 2 (2.5kV) pollution class 2, instrument class II	
	Electromagnetic compatibility	Compliance to the CE standards (see page 2)	
	UL and cUL Approval	File 176452	
	Protection EN60529 (IEC 529)	IP65 front panel	
Dimensions	1/4 DIN - 96 x 96, depth 110 mm, weight 500 g max.		



WARRANTY

We warrant that the products will be free from defects in material and workmanship for 3 years from the date of delivery.

The warranty above shall not apply for any failure caused by the use of the product not in line with the instructions reported on this manual.

ASCON'S WORLDWIDE SALES NETWORK

SUBSIDIARY

FRANCE

ASCON FRANCE

2 bis, Rue Paul Henri Spaak
ST. THIBAUT DES VIGNES
F-77462 LAGNY SUR MARNE - Cedex
Tél. +33 (0) 1 64 30 62 62
Fax +33 (0) 1 64 30 84 98
ascon.france@ascon.fr

AGENCE SUD-EST

Tél. +33 (0) 4 74 27 82 81
Fax +33 (0) 4 74 27 81 71

USA

ASCON CORPORATION

472, Ridgelawn Trail
Batavia, Illinois 60510
Tél. +1 630 482 2950
Fax +1 630 482 2956
www.asconcorp.com
info@asconcorp.com

DISTRIBUTORS

ARGENTINA

MEDITECNA S.R.L.

Phone +5411 4585 7005
Fax +5411 4585 3434

AUSTRALIA

IPA INDUSTRIAL PYROMETER

(AUST) PTY.LTD

Phone +61 8 8352 3688
Fax +61 8 8352 2873

FINLAND & ESTONIA

TIM-TOOL OY

Phone +358 50 501 2000
Fax +358 9 50 55 144

GERMANY

MESA INDUSTRIE ELEKTRONIK GMBH

Phone +49 2365 915 220
Fax +49 2365 915 225

GREECE

CONTROL SYSTEM

Phone +30 31 521 055-6
Fax +30 31 515 495

BRANCH OFFICE

Phone +30 1 646 6276
Fax +30 1 646 6862

HOLLAND

HSD INSTRUMENTS

Phone +31 78 617 03 55
Fax +31 78 618 26 68

PORTUGAL

REGUIPAMENTOS LDA

Phone +351 21 989 0738
Fax +351 21 989 0739

SPAIN

INTERBIL S.L.

Phone +34 94 453 50 78
Fax +34 94 453 51 45

BRANCH OFFICE

Phone +34 93 311 98 11
Fax +34 93 311 93 65
Phone +34 91 656 04 71
Fax +34 91 677 21 26

SWITZERLAND

CONTROLTHERM GMBH

Phone +41 1 954 37 77
Fax +41 1 954 37 78

TURKEY

KONTROL SISTEMLERI LTD











Phone +90 216 302 19 70-71
Fax +90 216 302 19 72













UNITED KINGDOM











EUKERO CONTROLS LTD

Phone +44 20 8568 4664
Fax +44 20 8568 4115

ICONS TABLE

Main universal input	
	Thermocouple
	RTD (Pt100)
	Delta Temp (2x RTD)
	mA and mV
	Custom
	Frequency
Auxiliary input	
	Current transformer
	mA Remote setpoint
	Volt Remote setpoint
	Feedback potentiometer

Digital input	
	Isolated contact
	NPN open collector
	TTL open collector
Setpoint	
	Local
	Stand-by
	Keypad lock
	Outputs lock
	Start-up function
	Timer function
	Memorized
	Remote
	Setpoint programmer

Digital input connected functions	
	Auto/Manual
	Run, Hold, Reset and program selection
	PV hold
	Setpoint slopes inhibition
Output	
	SPST Relay
	Triac
	SPDT Relay
	mA
	mA mV
	Logic