

Selection diagram

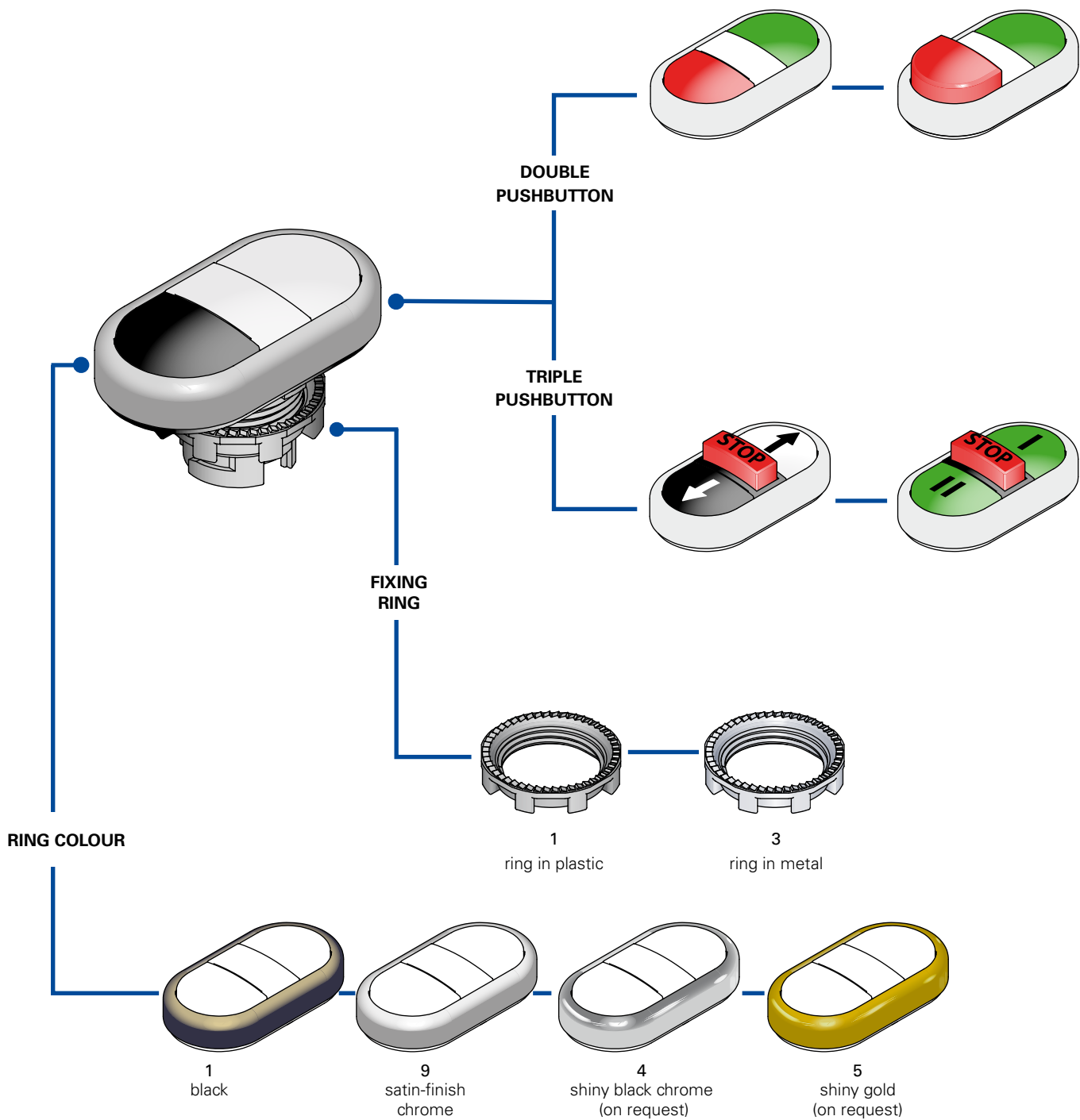

Double and triple pushbuttons code structure

article
options
E2 1PDRL10423-T6

Fixing ring and shaped ring	
1	ring in plastic
2	ring in plastic and shaped ring
3	ring in metal
4	ring in metal and shaped ring

Number of functions	
D	double pushbutton
T	triple pushbutton

Upper and lower pushbuttons	
A	upper projecting, lower flush
B	upper projecting, lower projecting
R	upper flush, lower flush
S	upper flush, lower projecting

Central element	
C	blanking plug (double pushbuttons only)
L	indicator light (double pushbuttons only)
S	projecting button (triple pushbuttons only)
Q	covering cap and actuators for adapter with 4 positions (only double push-buttons)

Ring colour	
1	black (standard)
9	satin-finish chrome (standard)
4	shiny black chrome (on request)
5	shiny gold (on request)

Ambient temperature	
	-25°C ... +85°C (standard)
T6	-40°C ... +85°C

Colour and markings						
	upper pushbutton		central element		lower pushbutton	
	colour	marking	colour	marking	colour	marking
0423	green	-	white	-	red	-
0221	white	-	white	-	black	-
0222	white	-	white	-	white	-
0121	black	-	white	-	black	-

	upper pushbutton		central element		lower pushbutton	
	colour	marking	colour	marking	colour	marking
AAAD	green	I	white	-	red	O
AAAP	green	START	white	-	red	STOP
AAAA	white	I	white	-	black	O
AAAN	white	START	white	-	black	STOP
AAAB	black	↑	white	-	black	↓
AAAC	black	+	white	-	black	-

	upper pushbutton		central projecting button		lower pushbutton	
	colour	marking	colour	marking	colour	marking
AAAY	green	I	red	STOP	green	II
AAAZ	green	←	red	STOP	green	→
AABD	white	→	red	STOP	black	←
AABA	green	↑	red	STOP	green	↓
AABE	white	↑	red	STOP	black	↓
AABF	black	↑	red	STOP	black	↓
AABB	green	+	red	STOP	green	-
AABC	white	+	red	STOP	white	-

Attention! The feasibility of a code number does not mean the effective availability of a product. Please contact our sales office.



Main features

- Protection degree IP67
- 2 or 3 pushbuttons versions
- Versions for -40°C
- Version with luminous central cap

Markings and quality marks:



Approval GOST: POCC IT.AB24.B04512

Technical data

General

Protection degree:	IP67 according to IEC 60529
Ambient temperature:	-25°C +80°C
Mechanical endurance:	1 million operations cycles ¹
Max operating frequency:	3600 operations cycles ¹ /hour
Actuating force at end travel:	4,4 (without contacts)
Maximum travel:	5 mm
Ring driving torque:	2 ... 2,5 Nm
Utilization requirements:	see page 3/98

(1) One operation cycle means two movements, one to close and one to open contacts, as foreseen by EN 60947-5-1 standard.

In conformity with standards:

IEC 60947-1, IEC 60947-5-1, IEC 60204-1, EN 60947-1, EN 60947-5-1, EN 60204-1, UL 508, CSA 22-2 N°14

⚠ Installation for safety applications:

Use only switches marked with the symbol \ominus . The safety circuit must always be connected with the **NC contacts** (normally closed contacts: 1-2) as stated in the standard EN 60947-5-1, encl. K, par. 2.

In conformity with requirements requested by:

Low Voltage Directive 2006/95/EC, Machinery Directive 2006/42/EC and Electromagnetic Compatibility 2004/108/EC.

Positive contact opening in conformity with standards:

IEC 60947-5-1, EN 60947-5-1, VDE 0660-206.

General characteristics

Shape

The new EROUND line double and triple pushbuttons are available in two shapes in order to suit any kind of application: projecting and flush. The possibility to choose shapes, colours and symbols allows various codes combinations.

Illuminated version

A version with central indicator light is available for double pushbuttons.

Fixing ring

A fixing ring in metal is also available in addition to the fixing ring in technopolymer.

The fixing ring in metal is particularly suitable for those applications which require tighter fitting of the panel-mounted device, such as for example in metal panels having holes without reference notches. Both rings feature a toothed surface which comes into contact with the inside of the panel in order to make it easier for the device to be secured to the actual panel.

Shaped ring

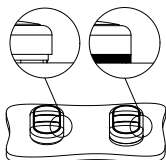

The shaped ring can be used when no label holders or other devices are applied; it prevents dirt and other residues from settling between the pushbutton and the panel or box. This turns out to be particularly useful in the sectors where high standards of cleanness and hygiene are required.

Mechanical endurance

Thanks to their particular design Pizzato Elettrica double and triple pushbuttons guarantee a Mechanical endurance of more than 1.000.000 operations.

Protection degree IP67

IP67 This series pushbuttons all have protection degree IP67, this way guaranteeing a total protection also in hard environmental conditions.





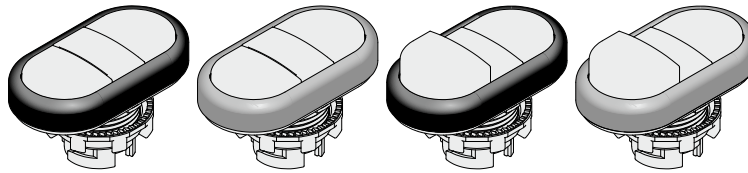

Temperature range extended

-40°C Special versions can be ordered for use in environments where the temperature changes from +80°C to -40°C.

They can be installed inside cold stores, sterilizers or other equipments with very low ambient temperature. Special materials that have been used to realize these versions, maintain unchanged their features also in these conditions, widening the installation possibilities.





Double pushbuttons selection table



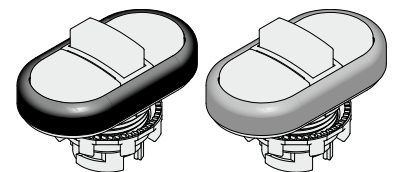
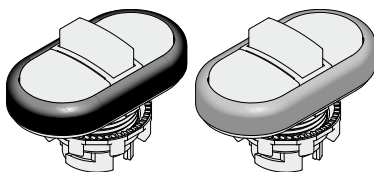



Actuator colour and marking	flush upper pushbutton flush central element flush lower pushbutton		flush upper pushbutton flush central element projecting lower pushbutton	
	black ring	satin chrome ring	black ring	satin chrome ring
 green pushbutton white indicator light red pushbutton "I"	E2 1PDRL10423	E2 1PDRL90423	E2 1PDSL10423	E2 1PDSL90423
 green pushbutton white indicator light "O" red pushbutton "START"	E2 1PDRL1AAAD	E2 1PDRL9AAAD	E2 1PDSL1AAAD	E2 1PDSL9AAAD
 green pushbutton white indicator light "STOP" red pushbutton white pushbutton white indicator light "STOP"	E2 1PDRL1AAAP	E2 1PDRL9AAAP	E2 1PDSL1AAAP	E2 1PDSL9AAAP
 white pushbutton white indicator light black pushbutton "I"	E2 1PDRL10221	E2 1PDRL90221	E2 1PDSL10221	E2 1PDSL90221
 white pushbutton white indicator light "O" black pushbutton "START"	E2 1PDRL1AAAA	E2 1PDRL9AAAA	E2 1PDSL1AAAA	E2 1PDSL9AAAA
 white pushbutton white indicator light "STOP" black pushbutton	E2 1PDRL1AAAN	E2 1PDRL9AAAN	E2 1PDSL1AAAN	E2 1PDSL9AAAN
 black pushbutton white indicator light black pushbutton ↑ ↓	E2 1PDRL1AAAB	E2 1PDRL9AAAB	E2 1PDSL1AAAB	E2 1PDSL9AAAB

Triple pushbuttons selection table



Actuator colour and marking	flush upper pushbutton projecting central pushbutton flush lower pushbutton	
	black ring	satin chrome ring
 "I" green pushbutton "STOP" red pushbutton "II"	E2 1PTRS1AAAY	E2 1PTRS9AAAY
 green pushbutton "STOP" red pushbutton ←	E2 1PTRS1AAAZ	E2 1PTRS9AAAZ
 green pushbutton "STOP" red pushbutton →	E2 1PTRS1AABD	E2 1PTRS9AABD
 white pushbutton "STOP" red pushbutton ←	E2 1PTRS1AABA	E2 1PTRS9AABA

Actuator colour and marking	flush upper pushbutton projecting central pushbutton flush lower pushbutton	
	black ring	satin chrome ring
 ↑ white pushbutton "STOP" red pushbutton ↓	E2 1PTRS1AABE	E2 1PTRS9AABE
 black pushbutton "STOP" red pushbutton ←	E2 1PTRS1AABF	E2 1PTRS9AABF
 black pushbutton "STOP" red pushbutton →	E2 1PTRS1AABB	E2 1PTRS9AABB
 green pushbutton "STOP" red pushbutton ↑	E2 1PTRS1AABC	E2 1PTRS9AABC

Items with code on the **green** background are available in stock

Double pushbuttons complete units

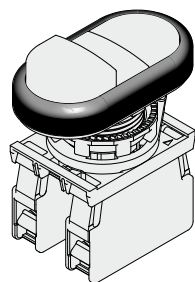

Actuator colour and marking		Contacts			flush upper button flush central element projecting lower button
		pos 2	pos 3	pos 1	black ring
	"I" green pushbutton black blanking plug "O" red pushbutton	1NC ⊖	-	1NO	E2 AC-DXBC0601 E2 1PDSC1AAAK + E2 1BAC11 + E2 CP01G2V1 E2 CP10G2V1

Triple pushbuttons complete units

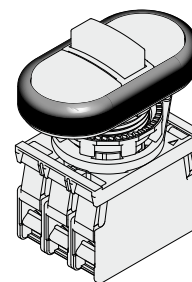

Actuator colour and marking		Contacts			flush upper button projecting central button flush lower pushbutton
		pos 2	pos 3	pos 1	black ring
	"I" green pushbutton "STOP" red pushbutton "II" green pushbutton	1NO	1NC ⊖	1NO	E2 AC-DXBC0801 E2 1PTRS1AAAY + E2 1BAC11 + E2 CP10G2V1 + E2 CP01G2V1 + E2 CP10G2V1

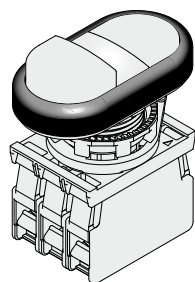

Actuator colour and marking		Contacts			flush upper button flush central element projecting lower button
		pos 2	pos 3	pos 1	black ring
	"I" green pushbutton white indicator light "O" red pushbutton	1NC ⊖	LED	1NO	E2 AC-DXBC0602 E2 1PDSL1AAAD + E2 1BAC11 + E2 CP01G2V1 + E2 LP1A2V1 + E2 CP10G2V1

Assembling minimum distances

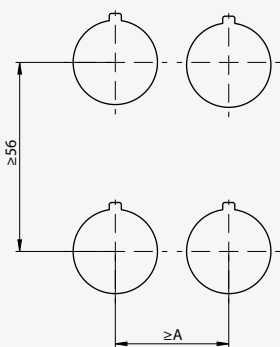

Fixing adapter with 3 positions
A=30 mm

Fixing adapter with 4 positions
A=40 mm

Accessories

➔ [ACCESSORIES at page 3/95](#)

➔ For the contact block and LED block characteristics see the respective chapters.

Protection hood

10 pcs packs

Article	Description
 VE CA1C1	Protection hood for double and triple projecting pushbutton
 VE CA1D1	Protection hood for double flush pushbutton

The shaped ring is not to be fitted when the protection hood is present.

Shaped ring

50 pcs packs

Article	Description
 VE GP12L1A	Shaped ring for double and triple pushbutton E2 1PD E2 1PT

The protection hood is not to be fitted when the shaped ring is present.

Dimensions

Flush double pushbutton

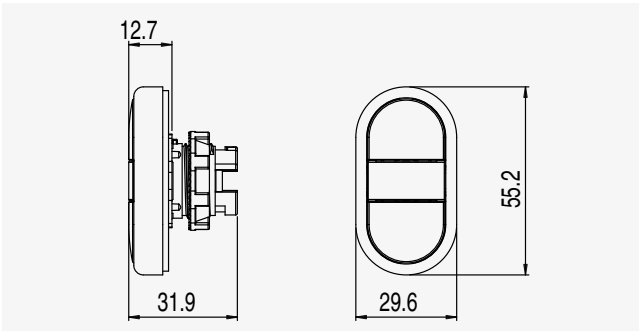

Projecting double pushbutton

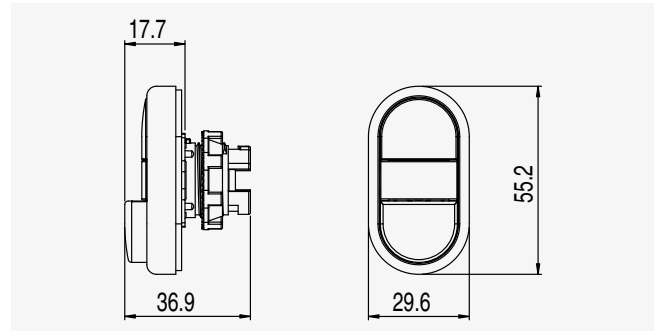

Triple pushbutton

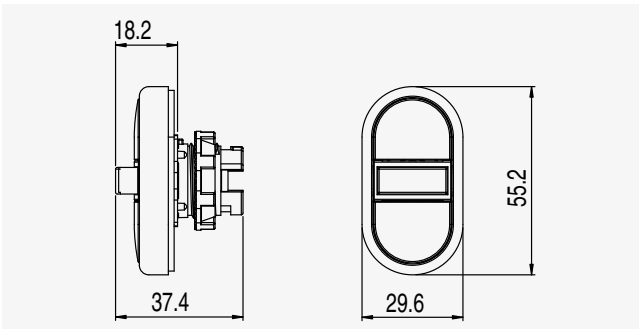

All measures in the drawings are in mm

→ [I2D and 3D files available on www.pizzato.com](http://www.pizzato.com)

Contacts maximum number

Fixing adapter with 3 positions

Double pushbutton E2 1PD●●●●●●



Maximum number:
contacts 4
levels 2

Triple pushbutton E2 1PT●●●●●●



Maximum number:
contacts 7
levels 3

Fixing adapter with 4 positions

Double pushbutton E2 1PD●Q●●●●●



Maximum number:
contacts 4
levels 1

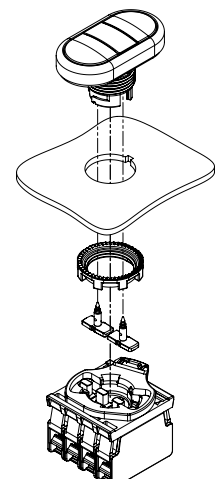
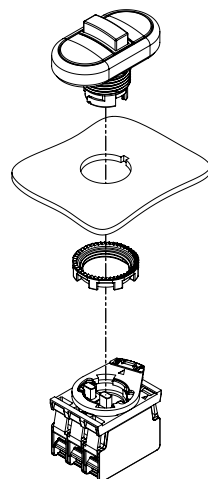

The actuators provided with the specific pushbutton for an adapter with 4 positions must be mounted after fixing the pushbutton.